

Introducción

PRESION DE VIENTO MAX. [kg/m ²] [1]	ESPESOR DE VIDRIO [2] [mm]	TACOS DE APOYO		CANT. DE ANCLAJES [4] AA408	CALIDAD MIN. DE H° [3] [8] [9]
		Código KIT	Cantidad x metro lineal baranda [7]		
100	8 + 8	AA 400	2	4	H-25
		AA 401	3	2	H-30 [5]
	10 + 10	AA 400	2	4	H-25
		AA 401	3	2	H-30 [5]
120	8 + 8	AA 401	3	2	H-30 [5]
	10 + 10	AA 400	2	4	H-25
		AA 401	3	2	H-30 [5]
140	8 + 8	AA 401	3	2	H-30 [5]
	10 + 10	AA 401	3	2	H-30 [5]
160	8 + 8	AA 402	3	3	H-25
	10 + 10	AA 402	3	3	H-25

[1]. Presión de viento determinada según CIRSOC 102.

[2]. Vidrio templado laminado.

[3]. Según CIRSOC 201-2005.

[4]. Anclajes Fischer Ultracut FBS II 8 x 100 50/35 US TX. (las cantidades indicadas son por kit).

[5]. Se admitirá H-25 si se colocan 3 anclajes por cada taco.

[6]. En barandas de escalera se deberán colocar 2 apoyos de 45 cm con vidrio 10 + 10.

[7]. En el caso de dos paños de vidrio contiguos, el taco se pondrá encaballado entre los mismos. En el caso de un vidrio extremo, el taco se colocará completo en el paño de vidrio.

[8]. En todos los casos los anclajes deben estar fijados en hormigón, anclados al menos 85 mm de profundidad y distar al menos 80 mm del filo externo del mismo.

[9]. El espesor mínimo de la losa deberá ser de 120 mm.

Procedimiento para colocación de tornillo Fischer Ultracut FBS II

El Sistema SKYLINE utiliza como accesorio de fijación para el taco de anclaje un tornillo para hormigón 8 x 100 mm cabeza hexagonal/torx.

Los pasos a seguir son los siguientes:

- Realizar los agujeros necesarios según el Kit seleccionado con una mecha para hormigón diámetro 8 mm. hasta una profundidad de 93 mm.
- Paso seguido, limpiar hasta 3 veces el alojamiento; de ser posible insuflando aire.
- Antes de presentar taco, agregar sellador neutro en orificio y posterior a la fijación en parte superior. (ver página 28)
- En zonas costeras marítimas se sugiere utilizar tornillo de acero inoxidable.
- Presentar el taco correspondiente, presentar los tornillos y fijar (de ser posible con atornillador de impacto con un torque máximo de 600 N/m) o en forma manual máximo de 65 N/m.
- Las llaves a utilizar son SW 13 o torx TX 40.
- Cualquier duda respecto de la instalación de este tornillo, se sugiere contactar al servicio de asistencia al cliente de Fischer Argentina s.a. (www.fischer.com.ar)

Perfiles (Escala 1:1)

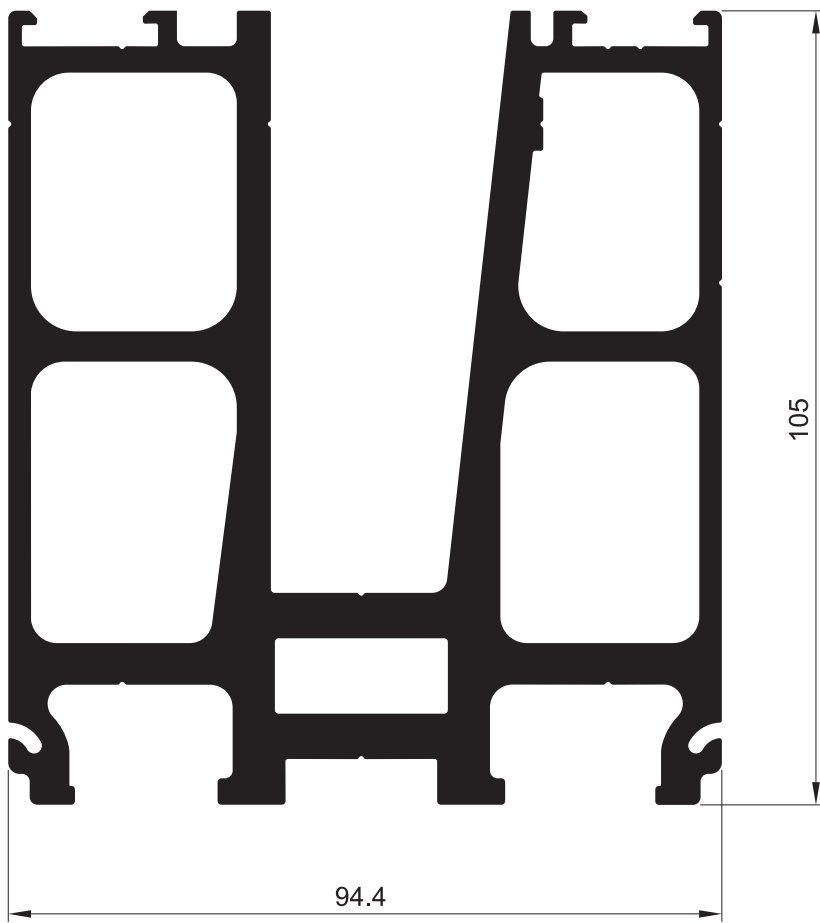

PERFIL ZAPATA
ADR 3580

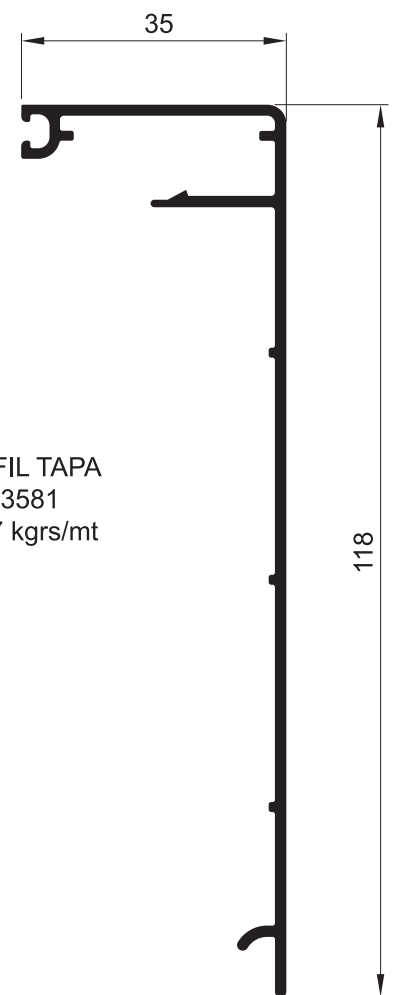

PERFIL TAPA
ADR 3581
0,757 kgrs/mt

Accesorios

AA 403-8
Cuña para Vidrio laminado 8 + 8 mm.

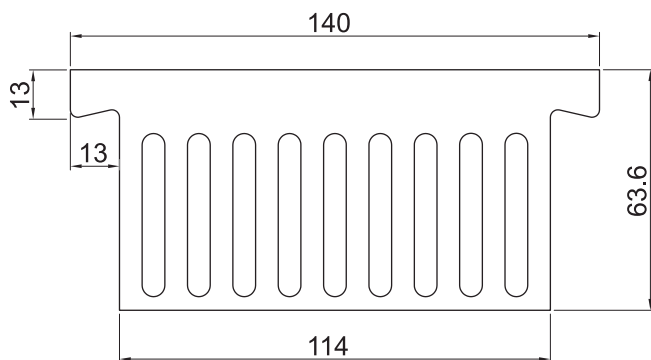

Material: Resina Acetal

AA 403-10
Cuña para Vidrio laminado 10 + 10 mm.

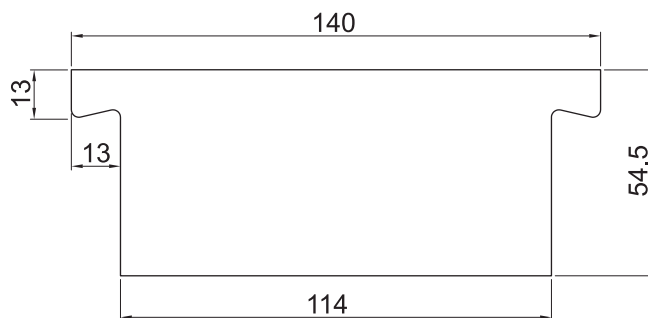

Material: Resina Acetal

AA 404
Traba de Seguridad para cuña

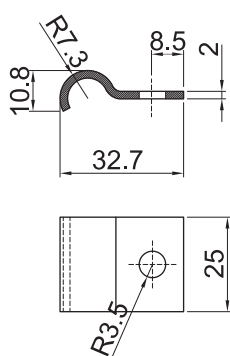

Material: Acero Inoxidable

AA 405
L apoyo Vidrio Laminado 140 x 22 x 1.7 mm.

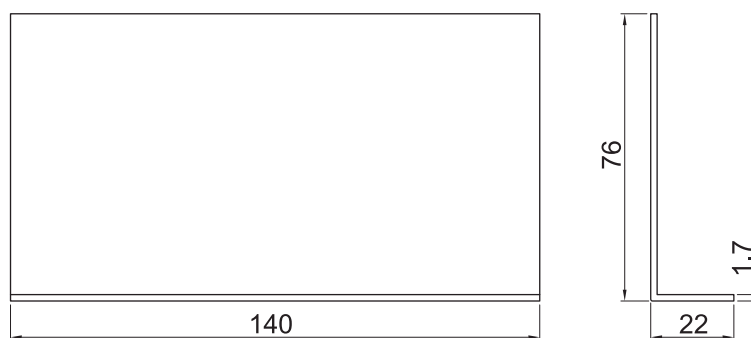

Material: Resina Acetal

Accesorios

AA 406
Tornillo cbza. cilíndrica allen M6 x 10 mm.

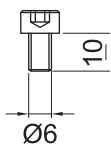

Material: Acero Inoxidable

AA 408
Tornillo p/hormigón
Fischer Ultracut FBS II 8 x 100

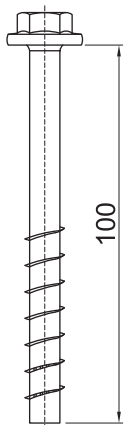

Material: Acero

AG 700
Burlate 4 mm.



AA 407
Tapa Lateral

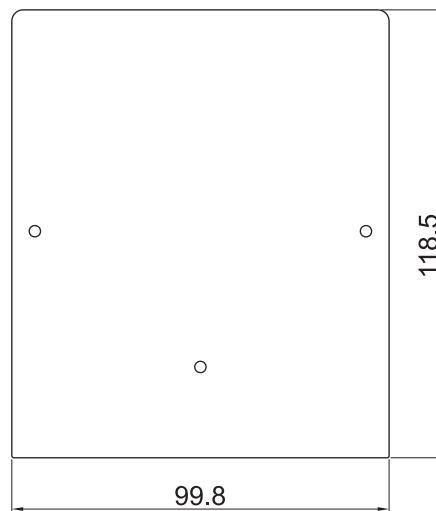

Material: Aluminio 3 mm. esp. prepintado

AA 272
Clip para perfil tapa



Material: Plástico

AG 701
Burlate 8 mm.



Kit AA 400

AA 400 RECTO / Largo: 450 mm.

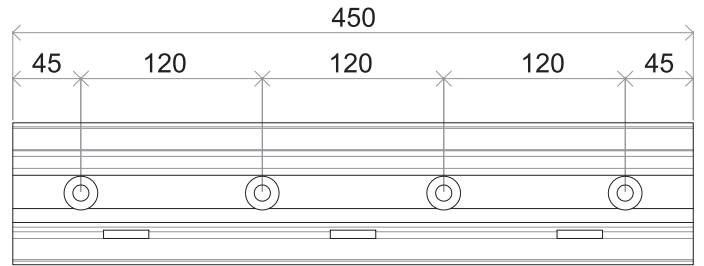

AA 403-10 (x 3)



AA 403-8 (x 3)

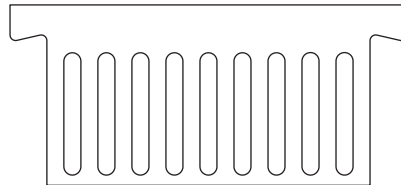

AA 272 (x 8)



AA 404 (x 3)



AA 405 (x 3)



AA 406 (x 3)



AA 408 (x 4)

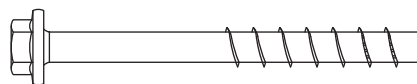

Kit AA 400

AA 400 IZQUIERDO 45° / Largo: 385 mm.

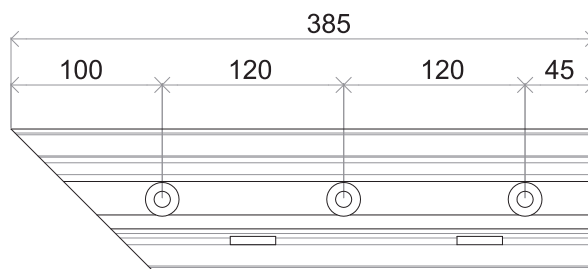

AA 403-10 (x 2)



AA 403-8 (x 2)

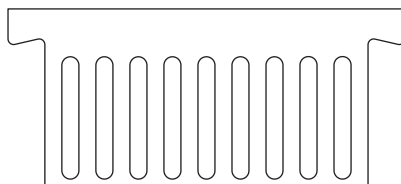

AA 272 (x 7)



AA 404 (x 2)



AA 405 (x 2)



AA 406 (x 2)



AA 408 (x 3)



Kit AA 400

AA 400 DERECHO 45° / Largo: 385 mm.

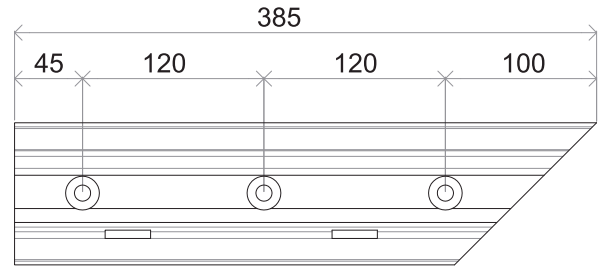
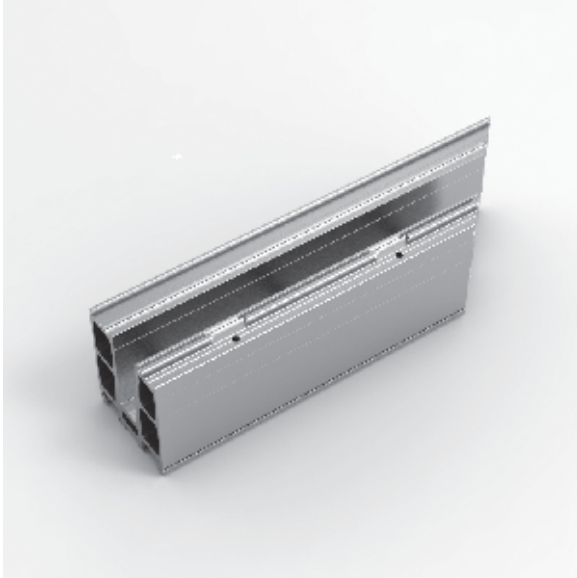

AA 403-10 (x 2)



AA 403-8 (x 2)

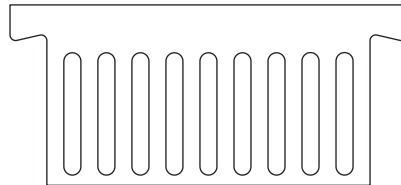

AA 272 (x 7)



AA 404 (x 2)



AA 405 (x 2)



AA 406 (x 2)



AA 408 (x 3)

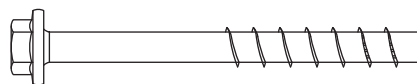

Kit AA 401

AA 401 RECTO / Largo: 300 mm.

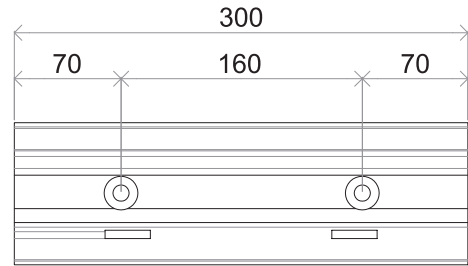

AA 403-10 (x 2)



AA 403-8 (x 2)

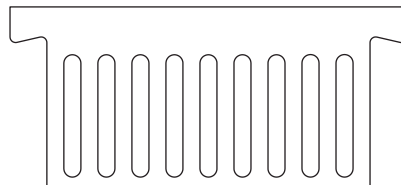

AA 272 (x 6)



AA 404 (x 2)



AA 405 (x 2)



AA 406 (x 2)



AA 408 (x 2)

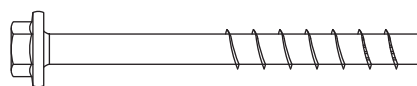

Kit AA 401

AA 401 IZQUIERDO 45° / Largo: 300 mm.

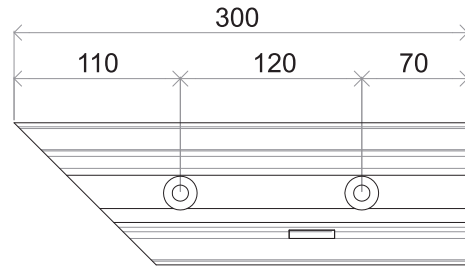

AA 403-10 (x 1)



AA 403-8 (x 1)

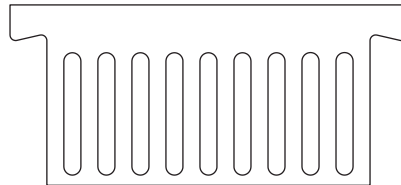

AA 272 (x 5)



AA 404 (x 1)



AA 405 (x 1)



AA 406 (x 1)



AA 408 (x 2)

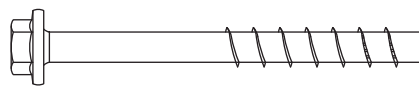

Kit AA 401

AA 401 DERECHO 45° / Largo: 300 mm.

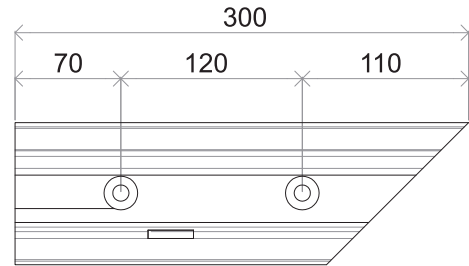

AA 403-10 (x 1)



AA 403-8 (x 1)

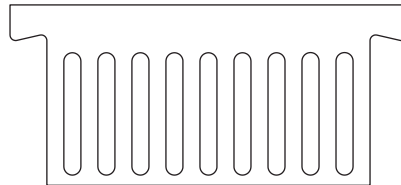

AA 272 (x 5)



AA 404 (x 1)



AA 405 (x 1)



AA 406 (x 1)



AA 408 (x 2)



Kit AA 402

AA 402 RECTO / Largo: 300 mm.

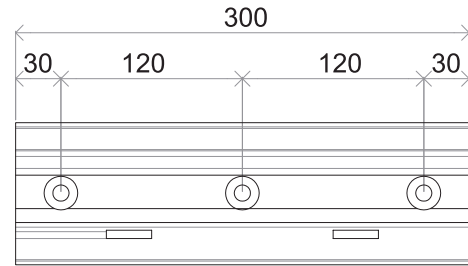

AA 403-10 (x 2)



AA 403-8 (x 2)

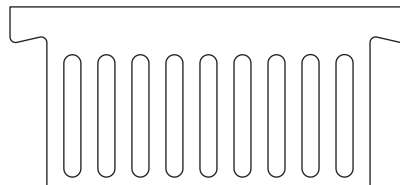

AA 272 (x 6)



AA 404 (x 2)



AA 405 (x 2)



AA 406 (x 2)



AA 408 (x 3)

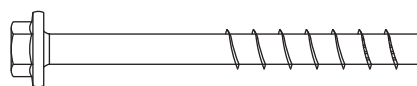

Kit

DESPIECE KIT

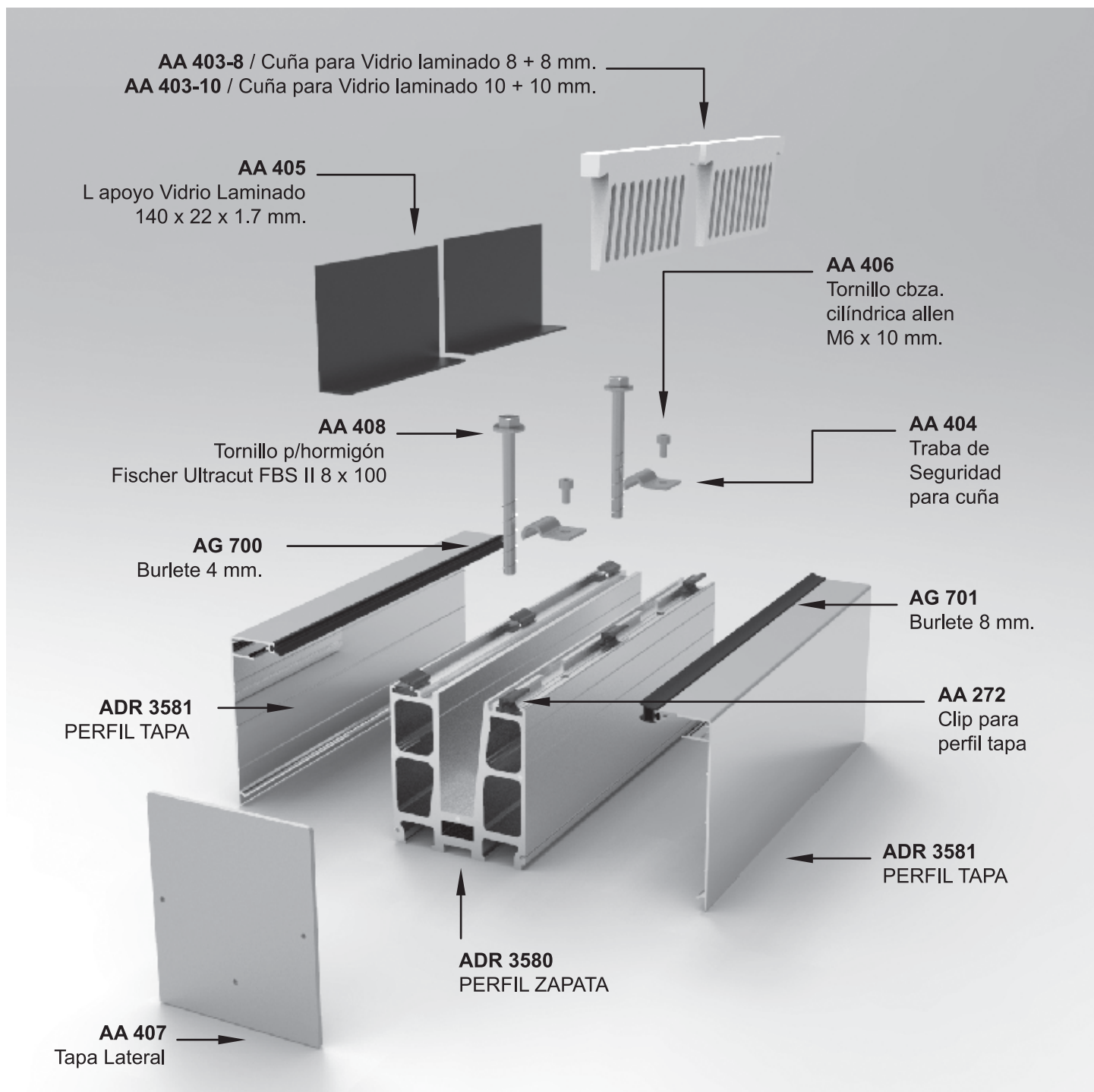

Detalles

VIDRIO 8 + 8 mm.

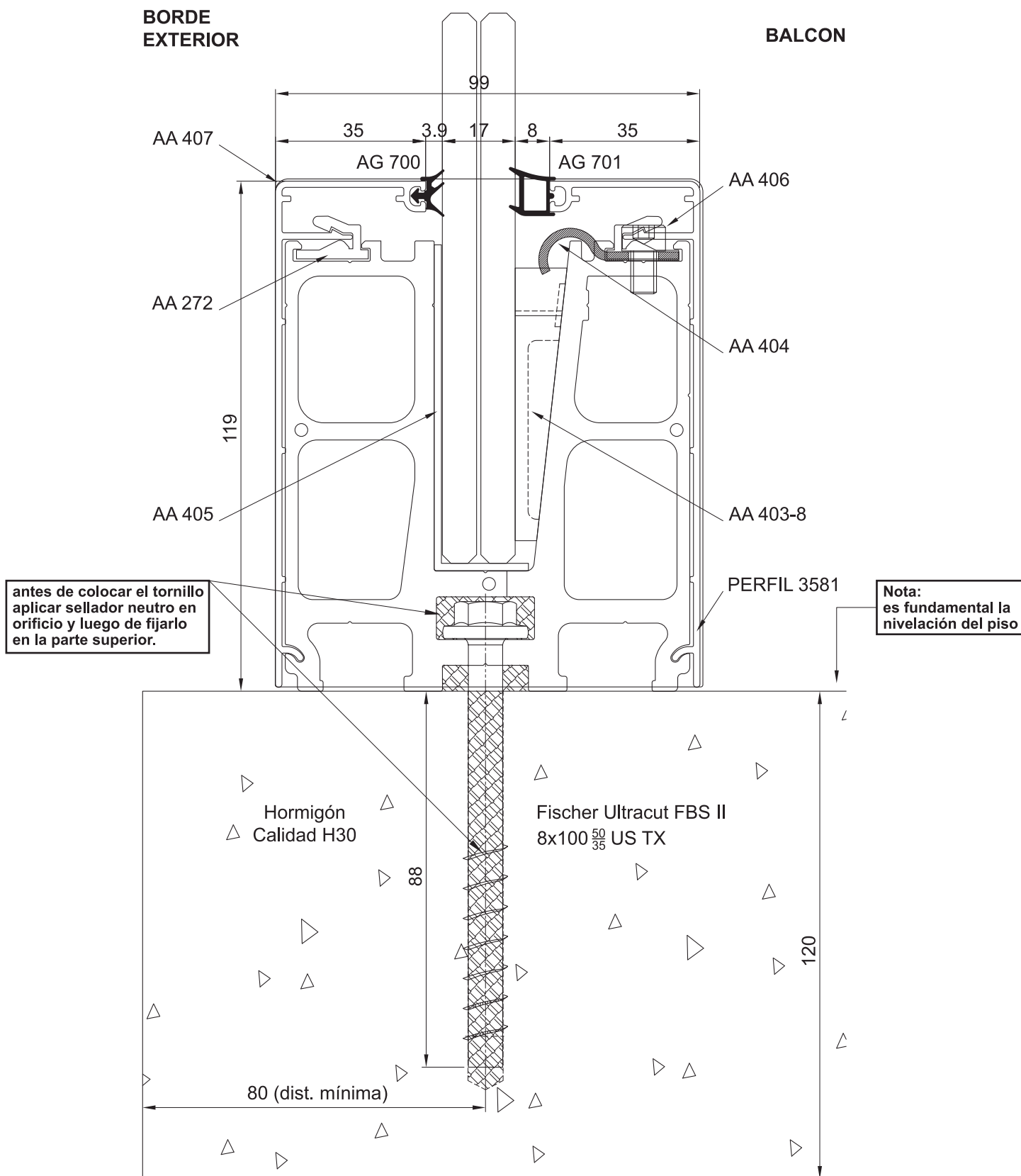

Detalles

VIDRIO 10 + 10 mm.

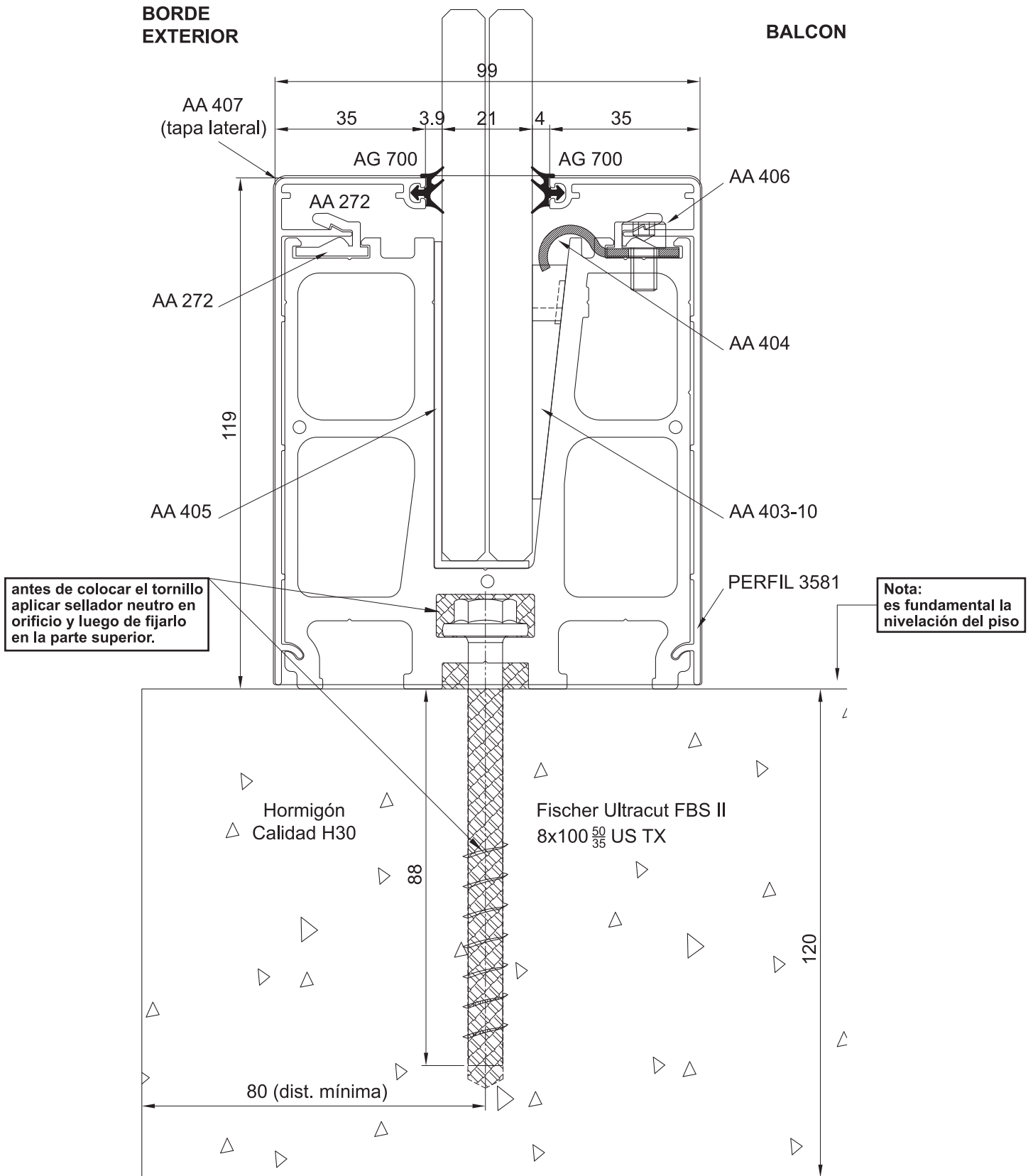

Detalles

DETALLE DE COLOCACION TAPA

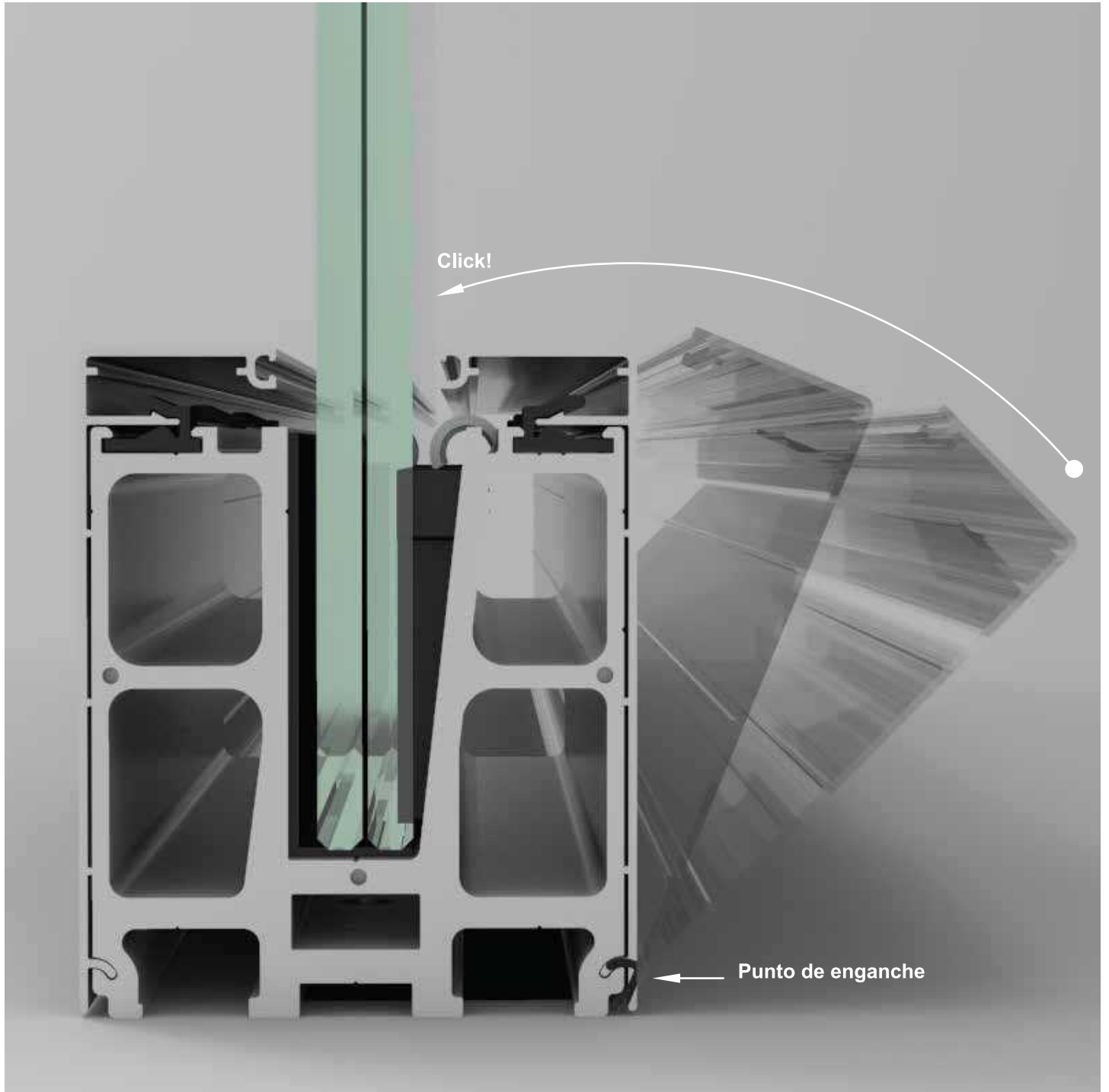

Esquema combinaciones de kits

AA 400 RECTO
DERECHO 45°

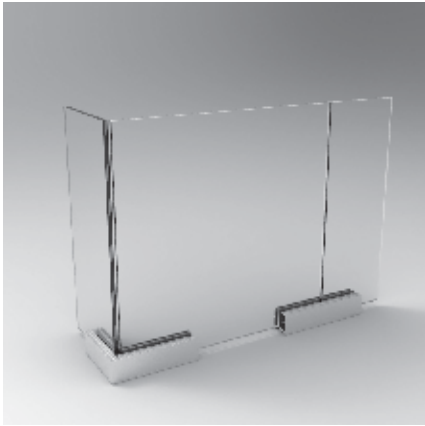

AA 400 RECTO

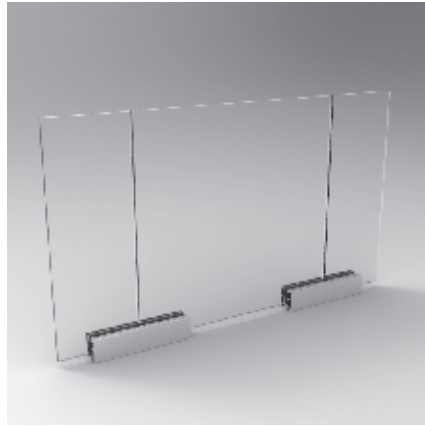

AA 400 RECTO
IZQUIERDO 45°

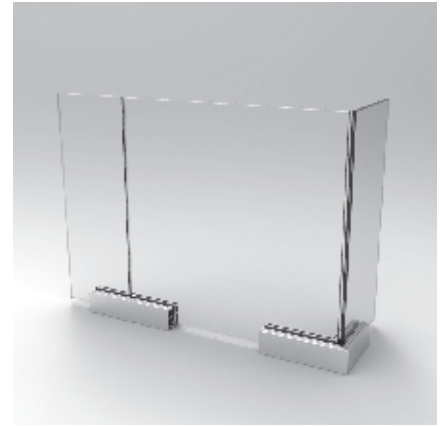

AA 401 RECTO
DERECHO 45°

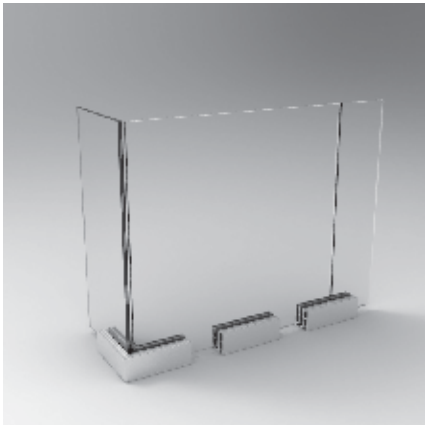

AA 401 RECTO

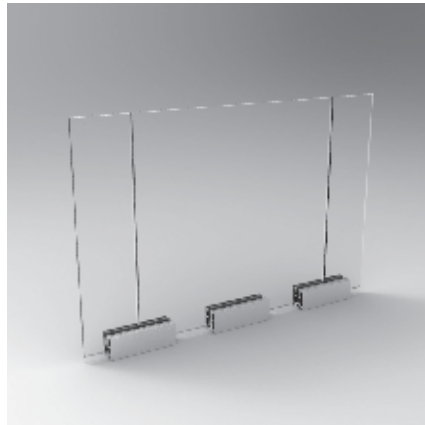

AA 401 RECTO
IZQUIERDO 45°



AA 402 RECTO

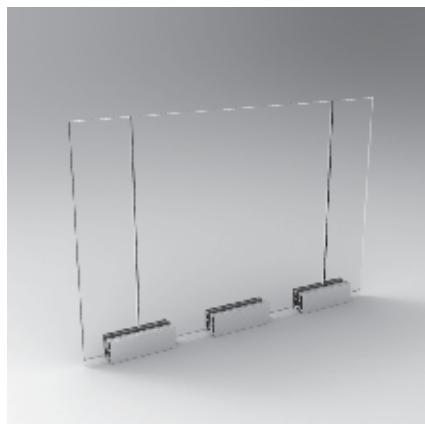

Medidas de modulación

AA 400 RECTO

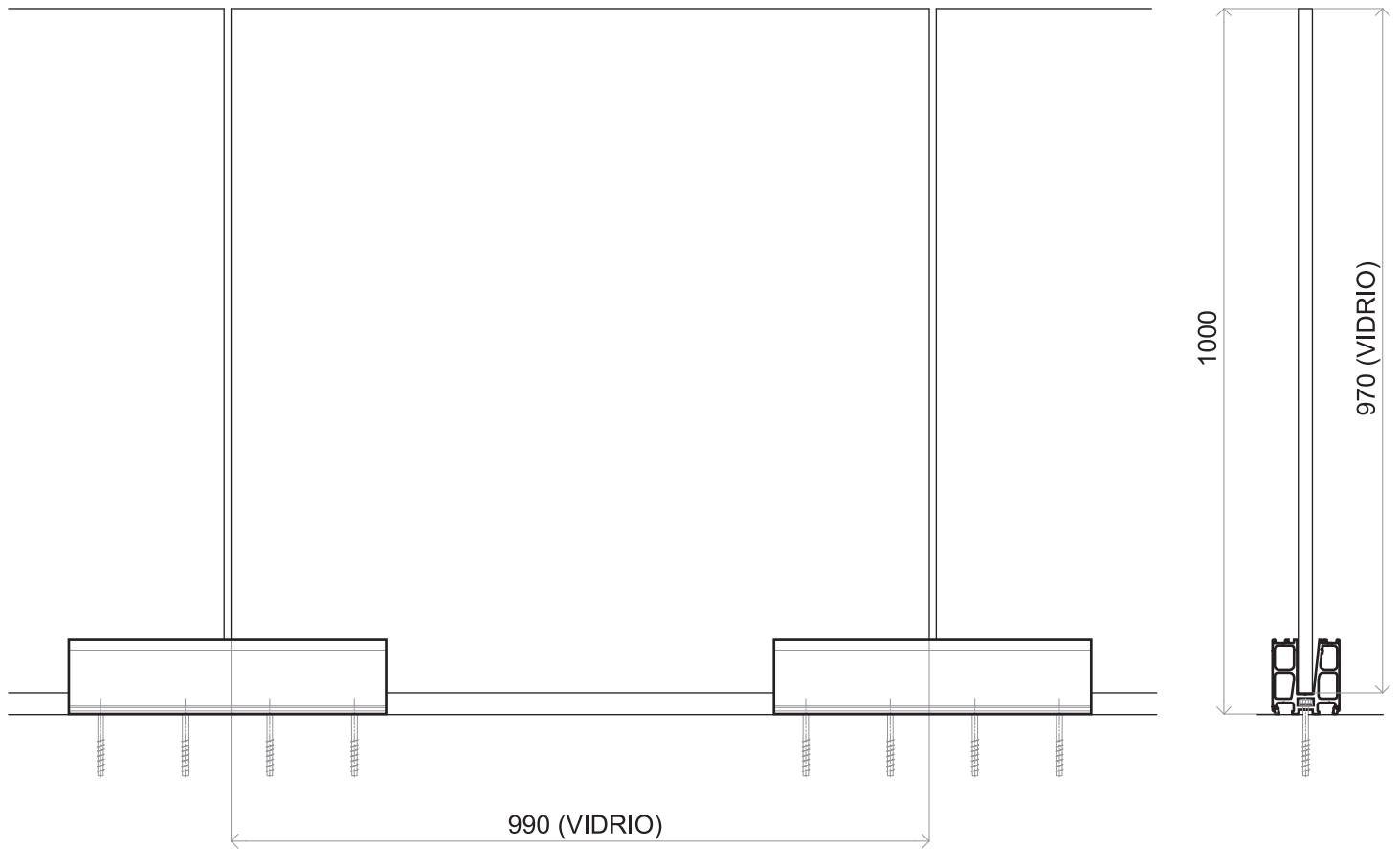

VISTA

CORTE

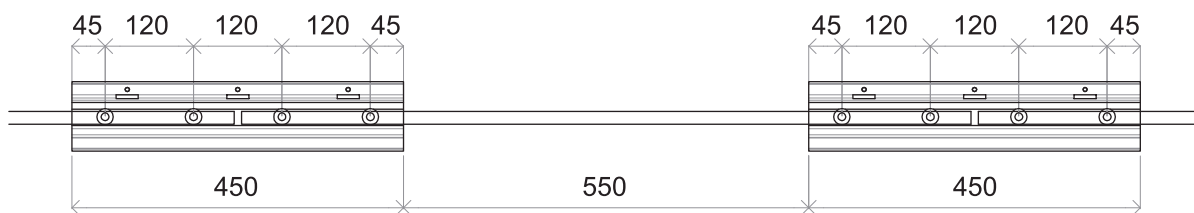

PLANTA

Medidas de modulación

AA 400 RECTO / IZQUIERDO 45°

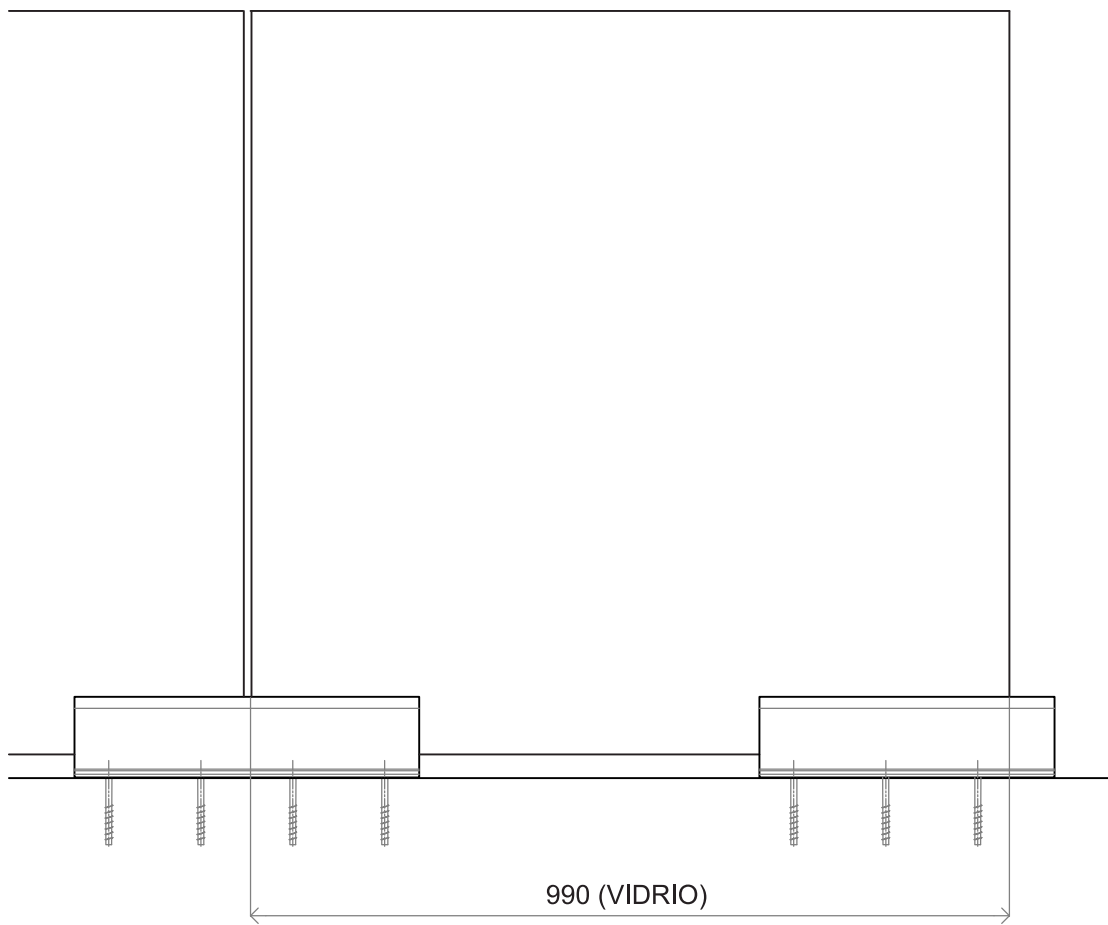

VISTA

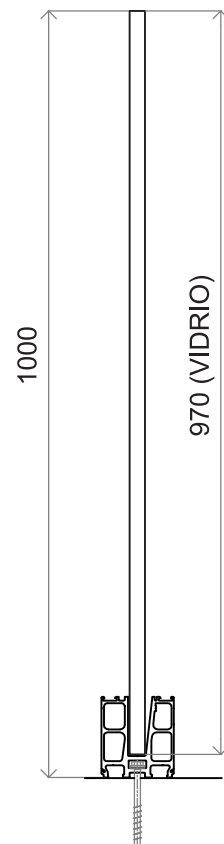

CORTE



PLANTA

Medidas de modulación

AA 400 RECTO / DERECHO 45°

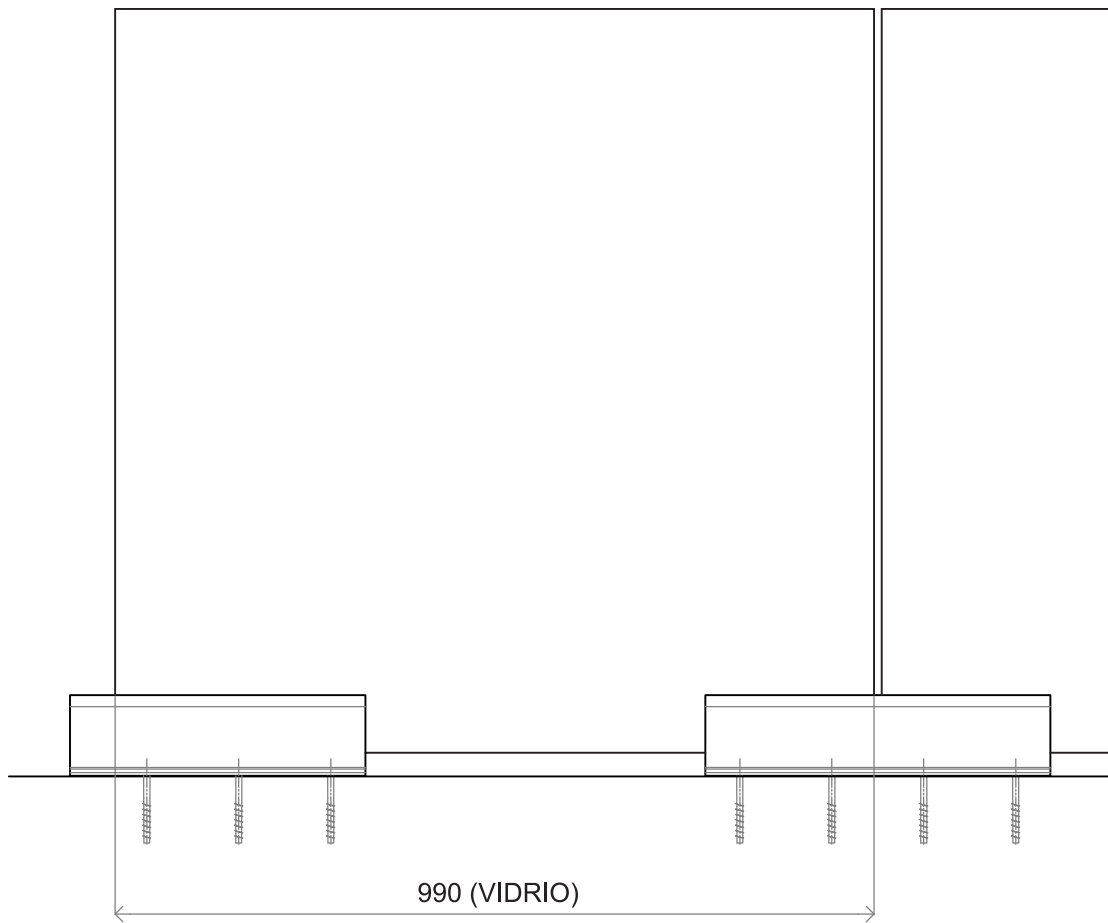

VISTA

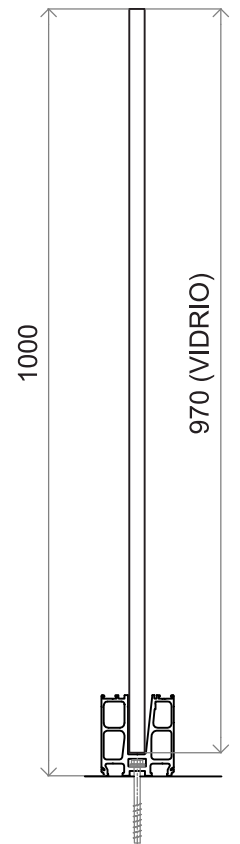

CORTE

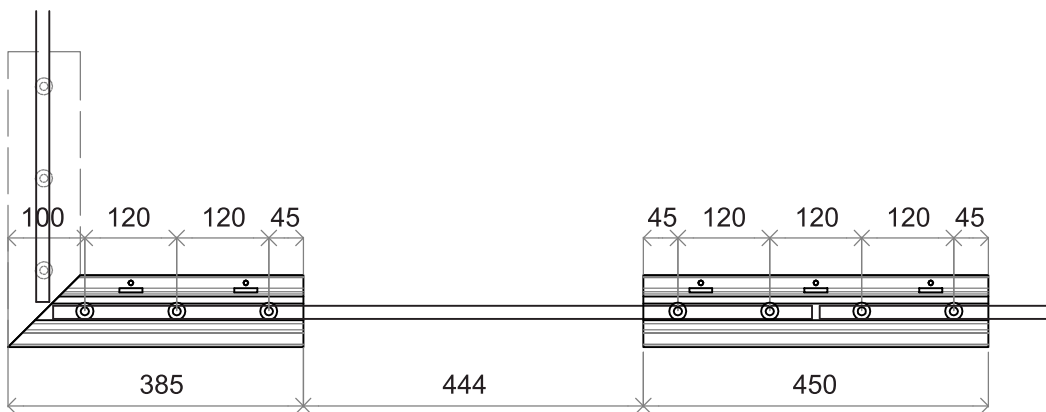

PLANTA

Medidas de modulación

AA 401 RECTO

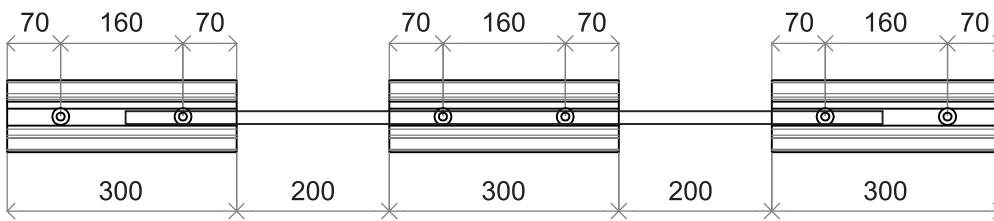
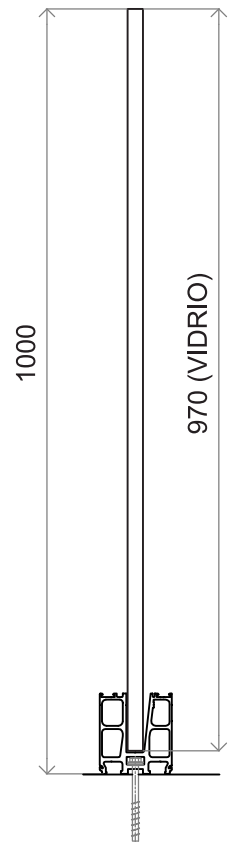
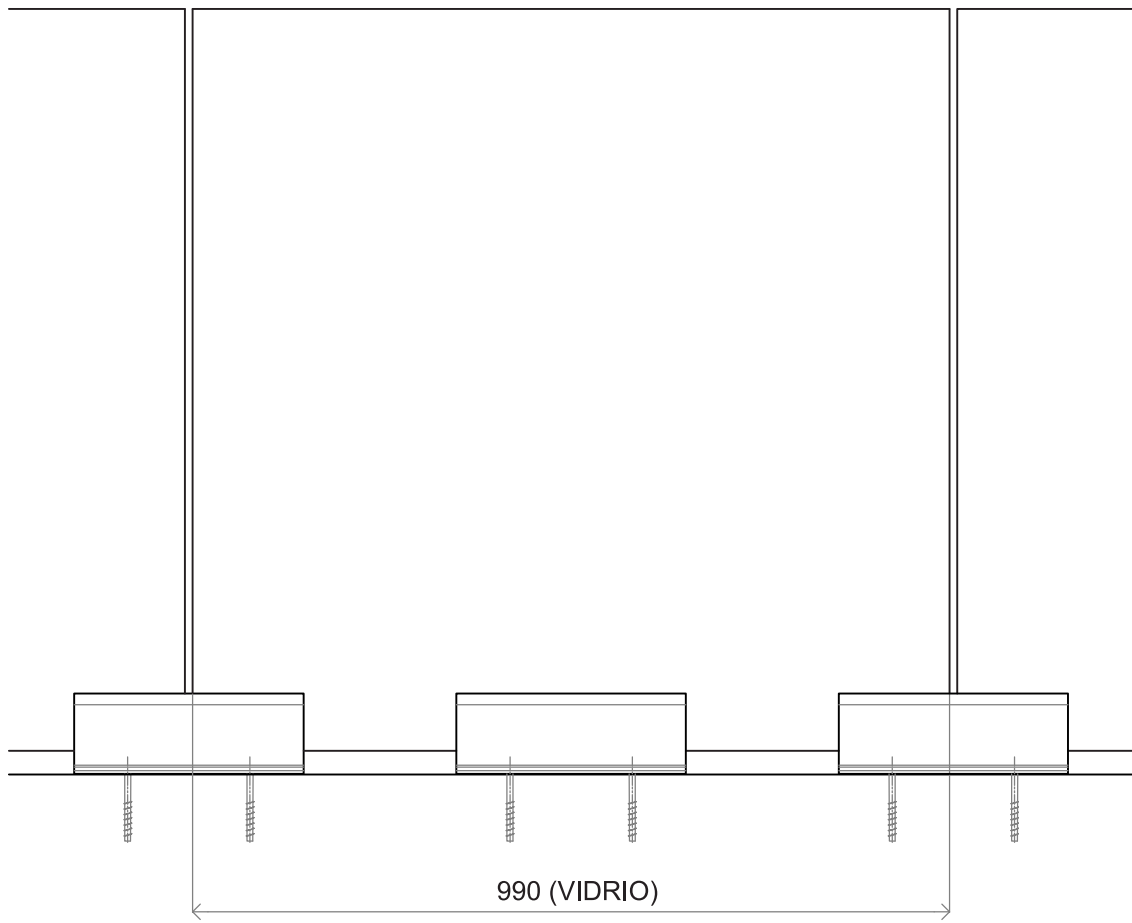

Medidas de modulación

AA 401 RECTO / IZQUIERDO 45°

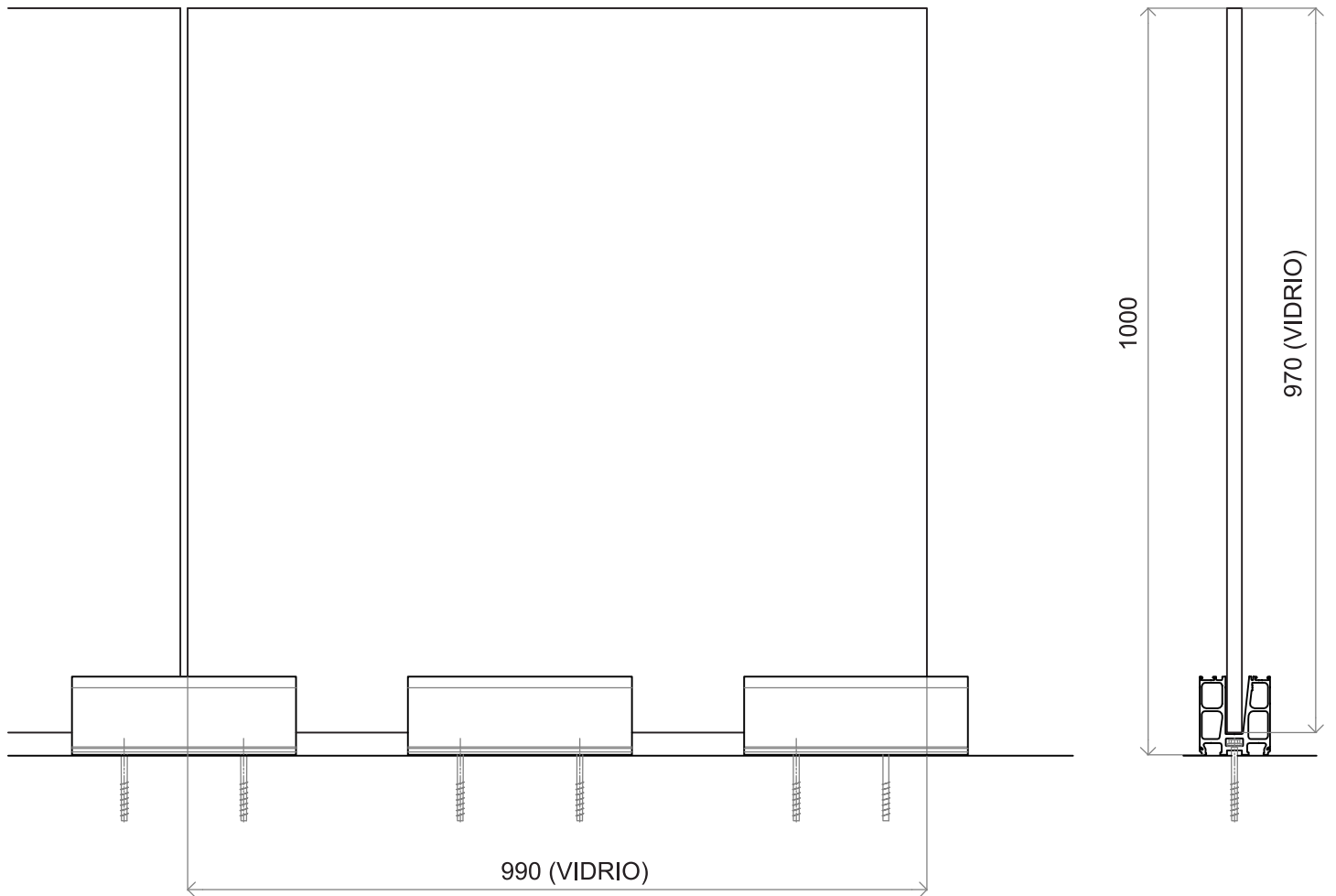

VISTA

CORTE

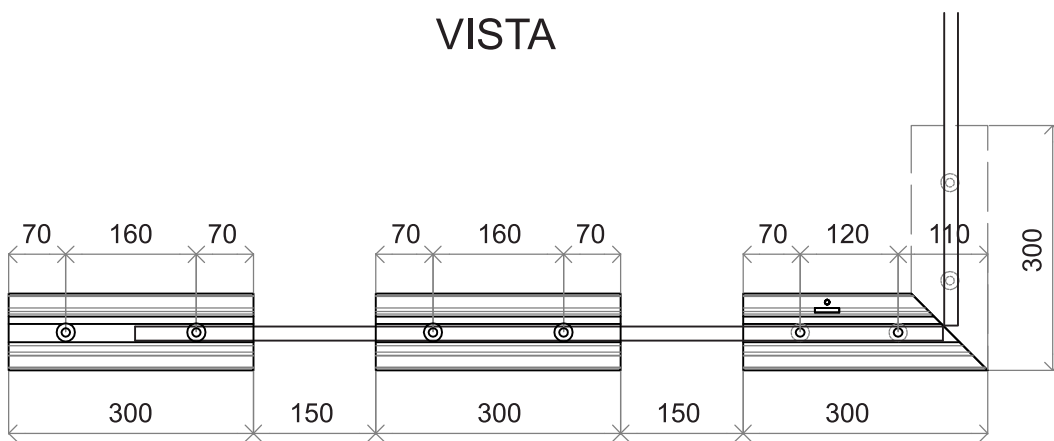

PLANTA

Medidas de modulación

AA 401 RECTO / DERECHO 45°

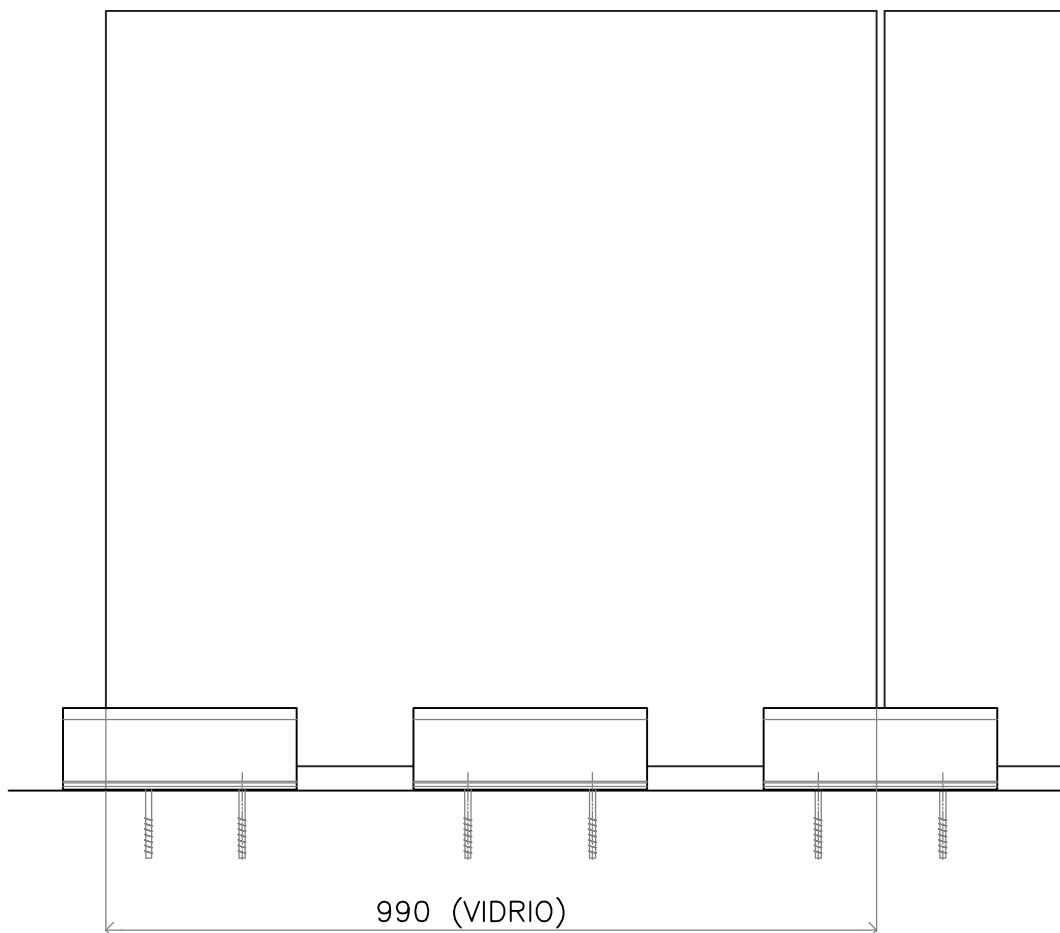

VISTA

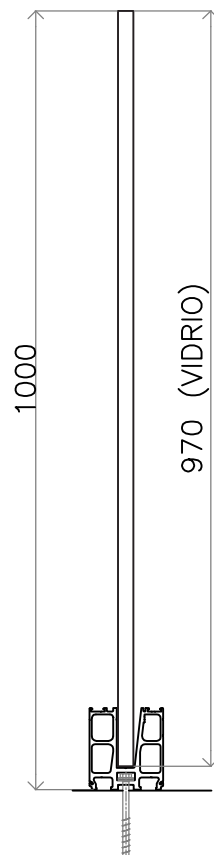

CORTE

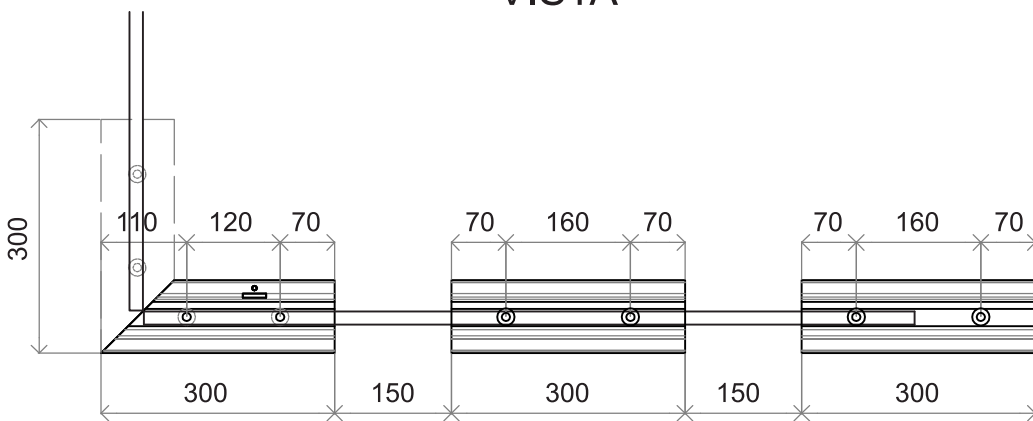

PLANTA

Medidas de modulación

AA 402 RECTO

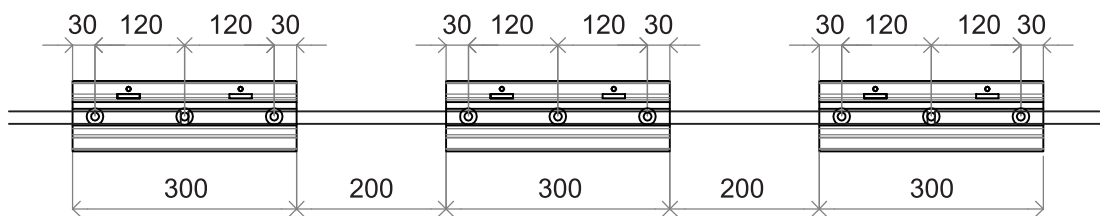
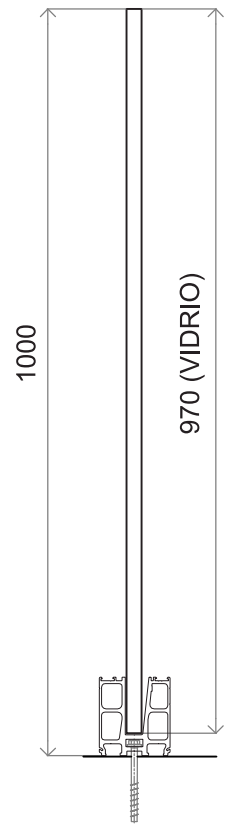
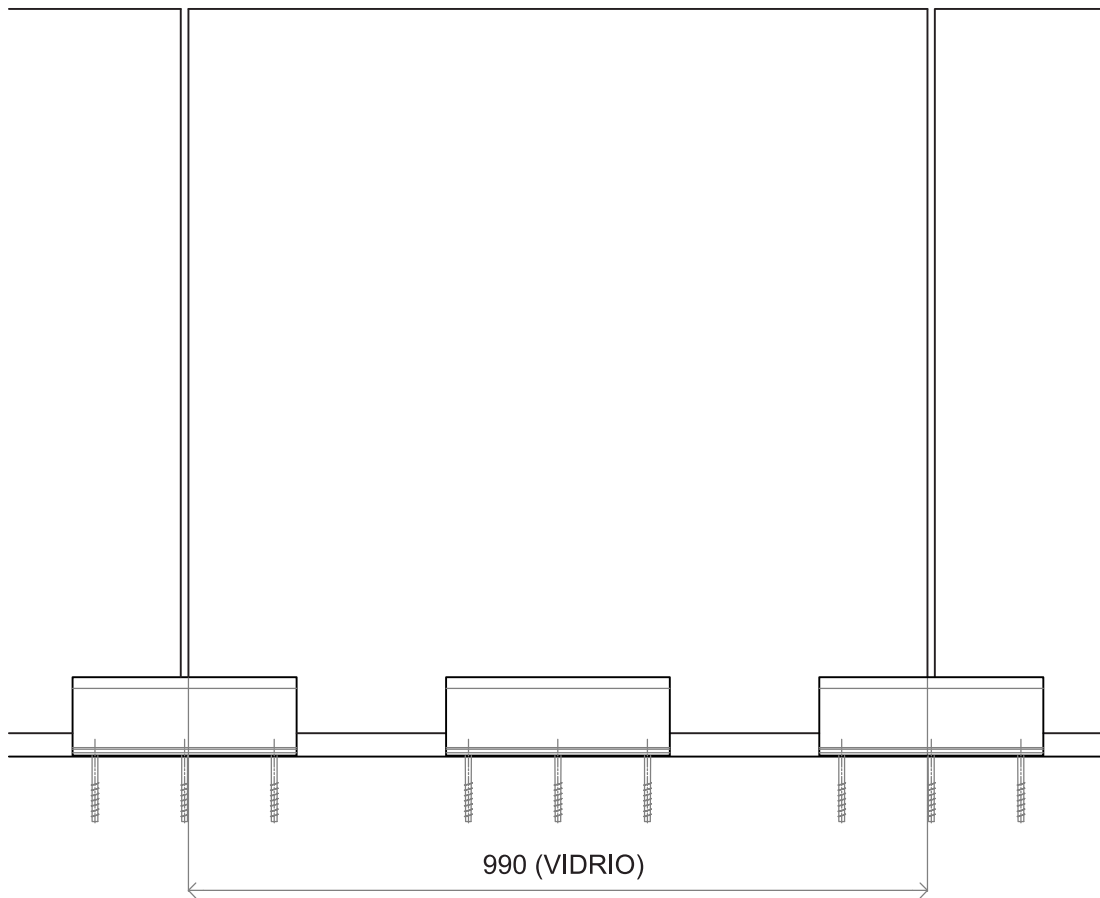

Nota Técnica

Secuencia de colocación de sellador neutro previo a la colocación del tornillo.

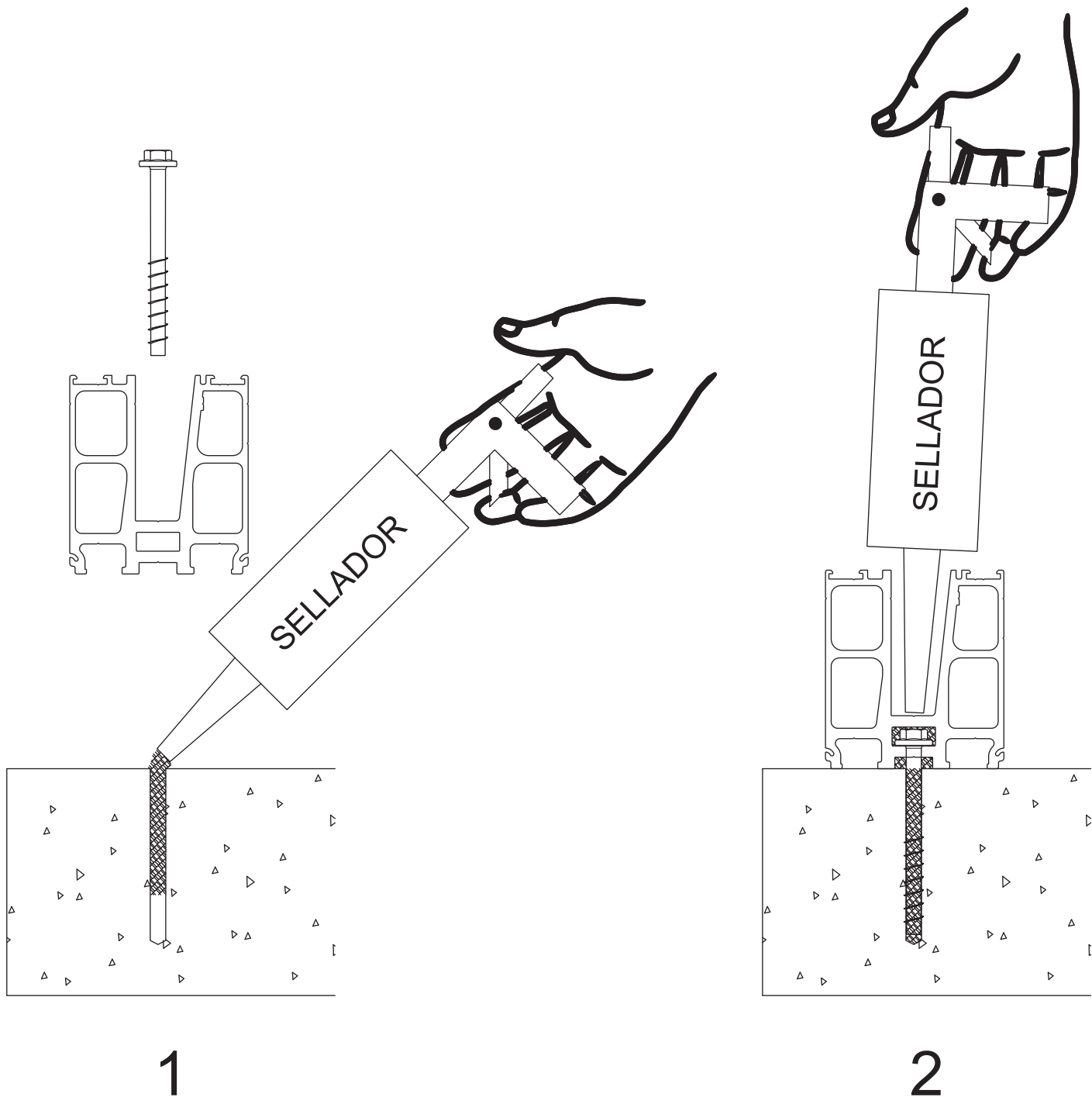

Perfiles (Escala 1:1)

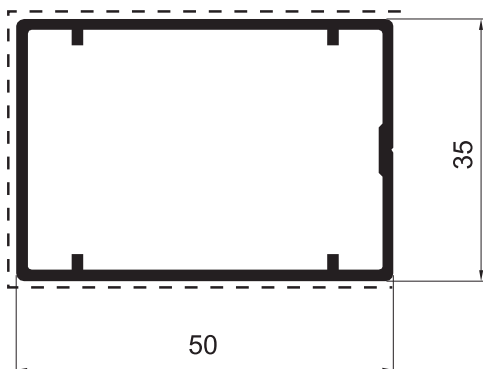

ADR 1462 Parante
Peso: 0,705 kg/m

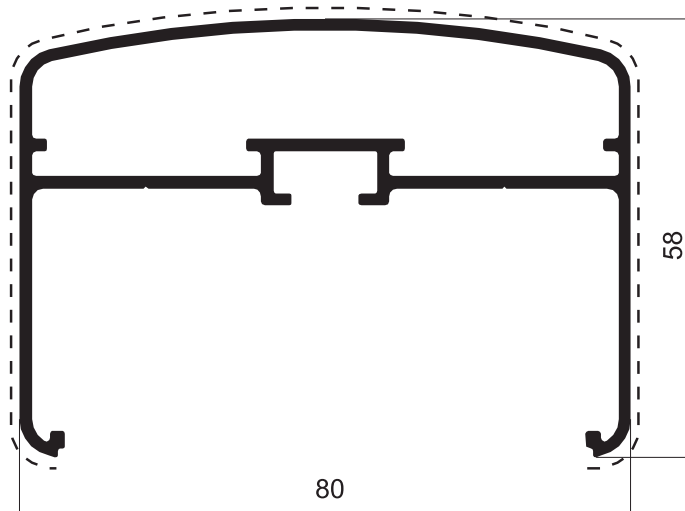

ADR 1463 Pasamanos
Peso: 1,270 kg/m

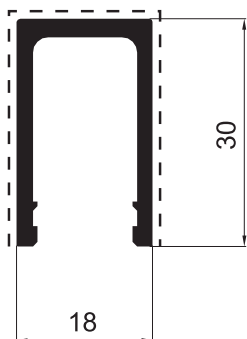

ADR 1464 U Porta Vidrio
Peso: 0,448 kg/m

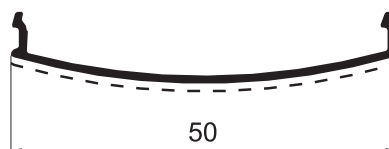

ADR 1465 Tapa Pasamanos
Peso: 0,180 kg/m

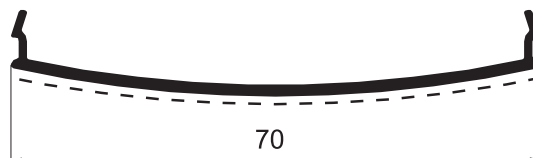

ADR 2047 Tapa inferior pasamanos
Peso: 0,343 Kg/m

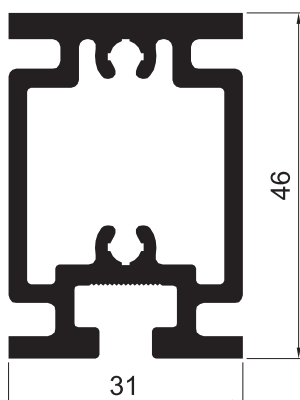

ADR 2164 Refuerzo Parante
Peso: 1,473 kg/m

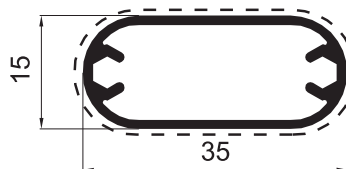

ADR 2000 Perfil barrote
Peso: 0,380 Kg/mtl.

--- Cara Vista

Perfiles (Escala 1:1)

Pasamanos 100 mm. para parante ADR 2706

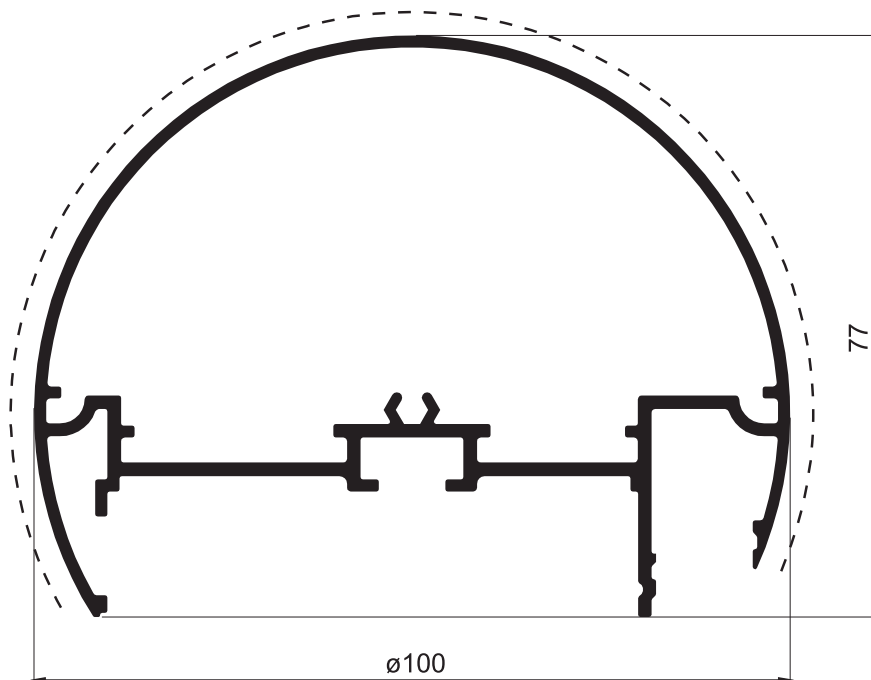

ADR 2771 Pasamanos
Peso: 1,758 kg/m
(Baranda reforzada)

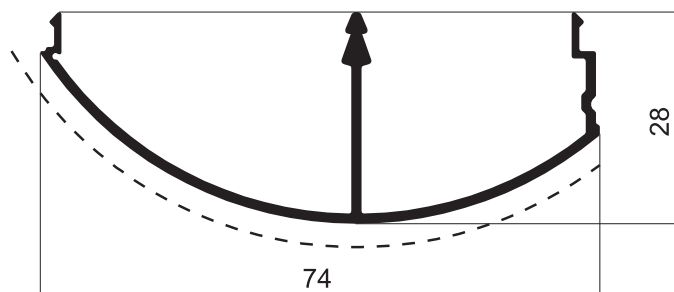

ADR 2772 Tapa Pasamanos
Peso: 0,502 kg/m
(Baranda reforzada)

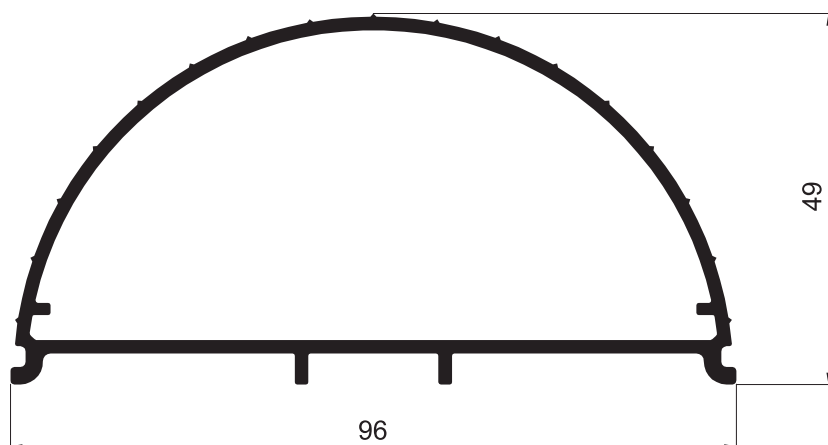

ADR 2773 Acople
Peso: 1,254 kg/m
(Baranda reforzada)

--- Cara Vista

Perfiles (Escala 1:1)

Pasamanos 95 mm. para parante ADR 2706

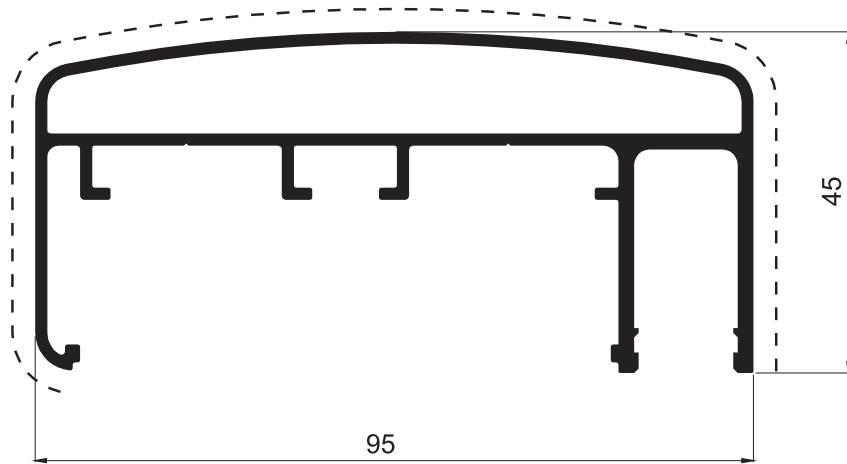

ADR 3011 Pasamanos
Peso: 1,539 kg/m
(Baranda reforzada)

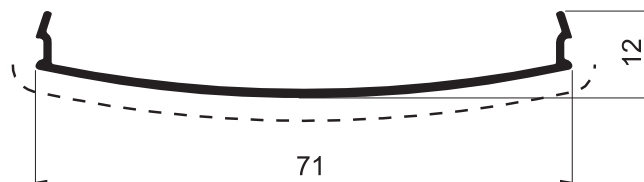

ADR 3012 Tapa Pasamanos
Peso: 0,278 kg/m
(Baranda reforzada)

--- Cara Vista

Perfiles (Escala 1:1)

Parante 70 X 40 mm. reforzado

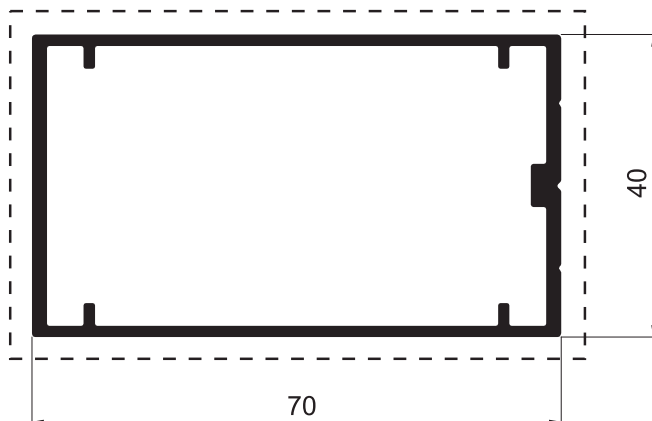

ADR 2706 Parante
Peso: 1,044 kg/m
(Baranda reforzada)

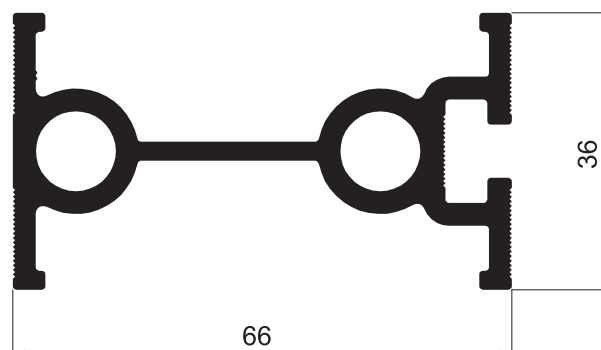

ADR 2707 Anclaje Parante
Peso: 1,508 kg/m
(Baranda reforzada)

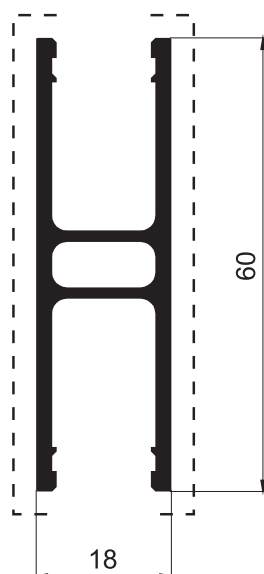

ADR 3013 U porta blisam doble
Peso: 0,830 kg/m
(Baranda reforzada)

--- Cara Vista

Accesorios

Kit de accesorios AA358 Baranda reforzada



Soporte pasamanos ADR 2771
Código AA358-1

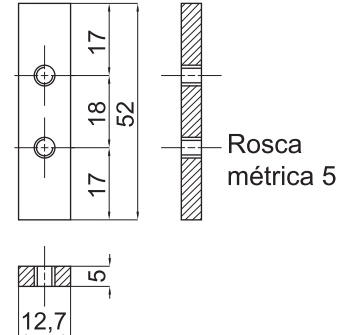
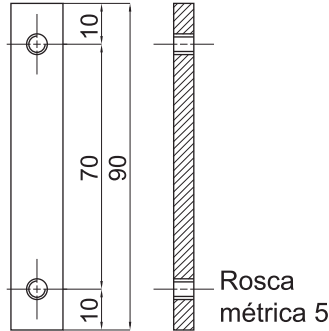

Soporte pasamanos ADR 3011
Código AA358-2

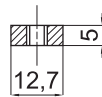

Contratuercas soporte pasamanos material bronce
Código AA358-4

Contratuercas soporte parante - base anclaje material acero inoxidable
Código AA350-3

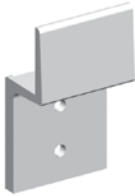

Soporte inferior U
Código AA351

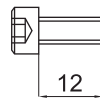

Tornillo cilíndrico c/hexagonal Int. M5 x 12 mm. SAE 1045

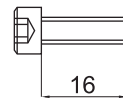

Tornillo cilíndrico c/hexagonal Int. M5 x 16 mm. Acero inox. cal 304



ADR 2707 Anclaje Parante
Código AA358-3



Código AA358-7 Varilla roscada 3/8'' acero SAE 1045 galvanizado con tuerca autofrenante y arandela grover. Para zonas costeras marítimas se aconseja usar varilla de acero inoxidable.

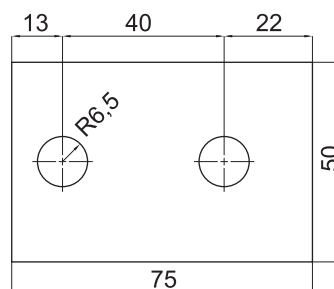

Base apoyo parante reforzado material aluminio código AA358-5



Clip inferior tapa pasamanos ADR 2771 material plástico - PVC código AA358-6

Modulación

Baranda Reforzada

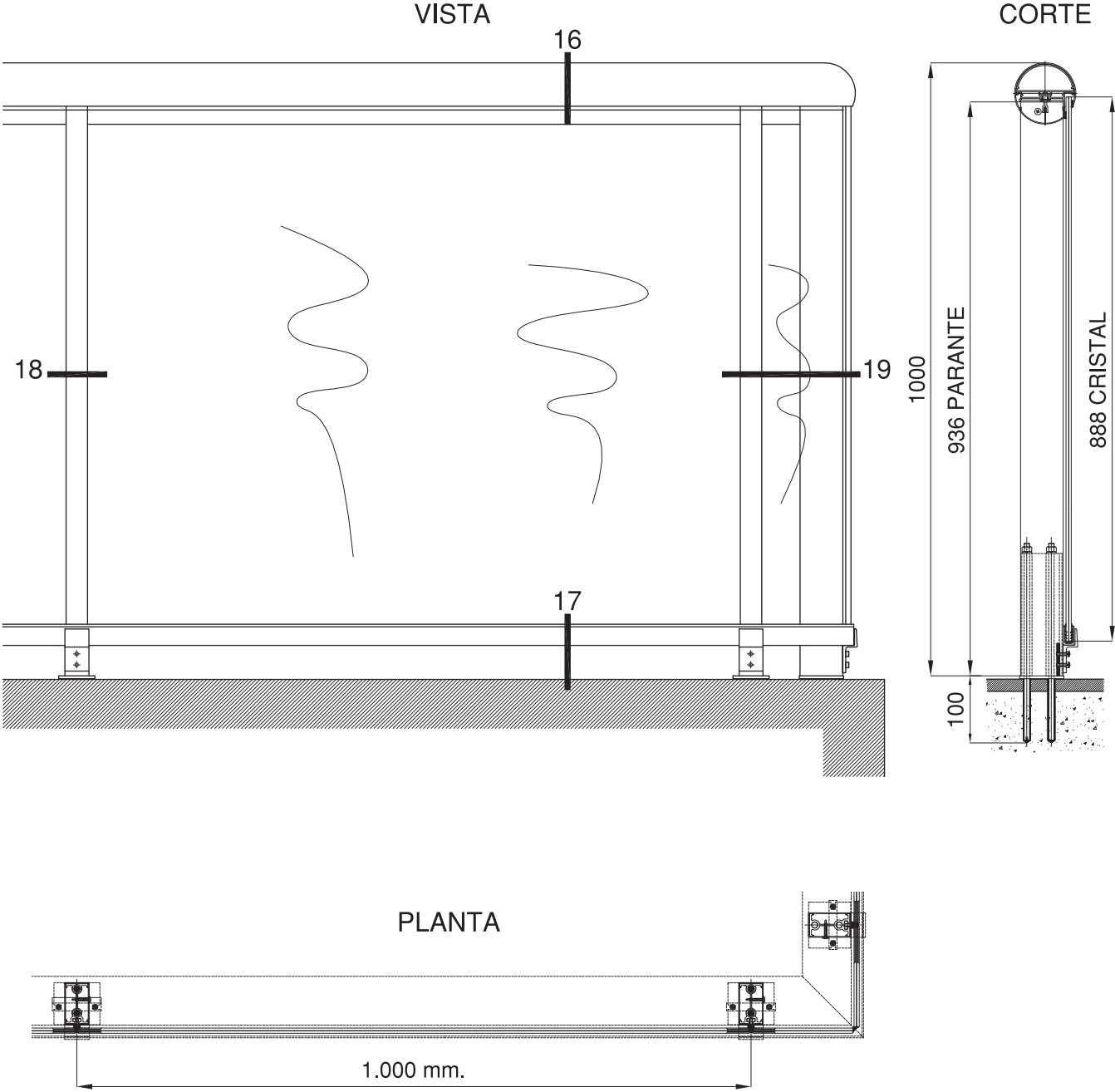

Accesorios

Kit de accesorios AA357 Frente losa

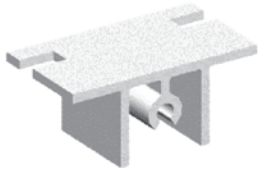

Soporte pasamanos
Código AA350-5

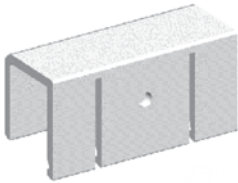

Soporte superior U
Código AA350-4



Arandela para anclaje
material acero inoxidable
cal. 304,
Código AA357-4

Anclaje frente losa
Código AA357-1
Longitud en función de
cálculo estructural

Tornillo cilíndrico
c/hexagonal Int. M6 x 50 mm.
Acero inox. cal 304



Tornillo cilíndrico
c/hexagonal Int. M6 x 40 mm.
Acero inox. cal 304

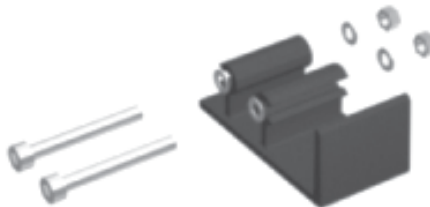

Soporte inferior U
Código AA357-2



Código ADR1466
Refuerzo parante
Código AA357-3
(No incluido en el kit)

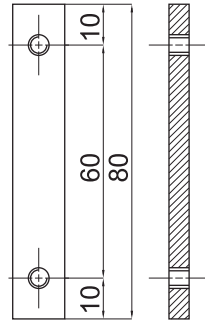

Contratuerca soporte pasamanos
material aluminio
Código AA350-6

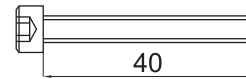

Tornillo cilíndrico c/hexagonal Int.
M6 x 40 mm.
SAE 1045



Tornillo cilíndrico c/hexagonal Int.
M5 x 12 mm.
SAE 1045

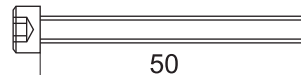

Tornillo cilíndrico c/hexagonal Int.
M6 x 50 mm.
Acero inox. cal 304

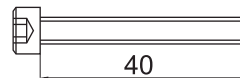

Tornillo cilíndrico c/hexagonal Int.
M6 x 40 mm.
Acero inox. cal 304



Tornillo Parker ó autoperforante
Cza. fijadora 8 x 13 mm.

Modulación

Baranda Cristal Laminado - Frente Ilosa

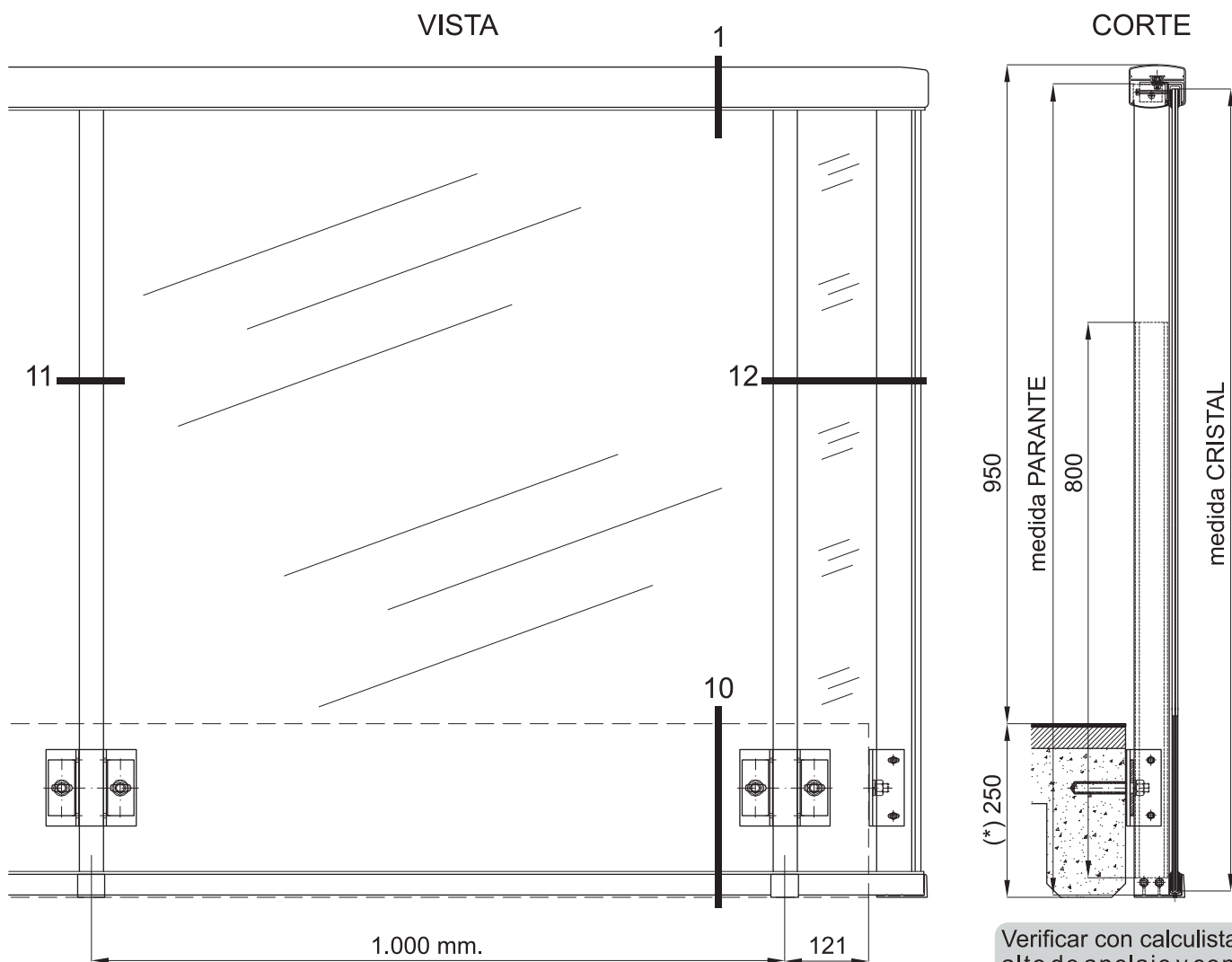

Verificar con calculista alto de anclaje y con fabricante anclaje químico aplicación sobre hormigón.

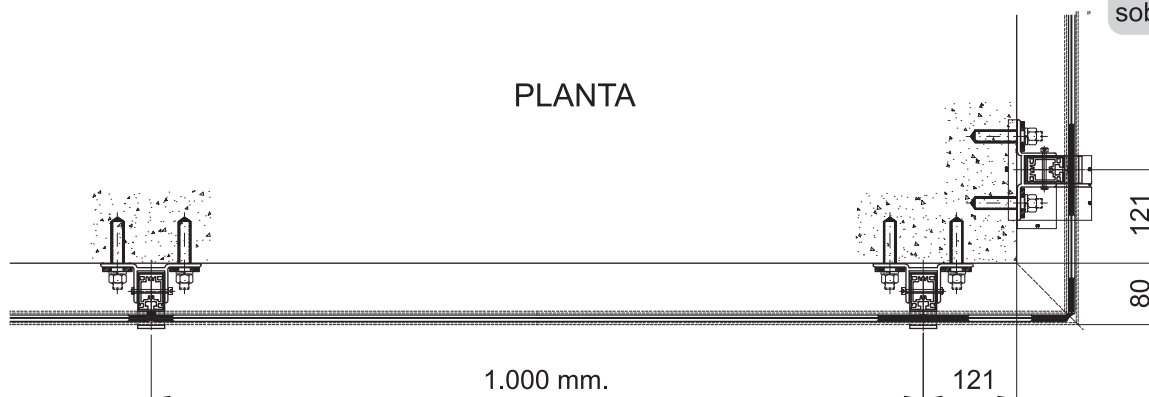

Cortes

Baranda Cristal Laminado - Frente lisa

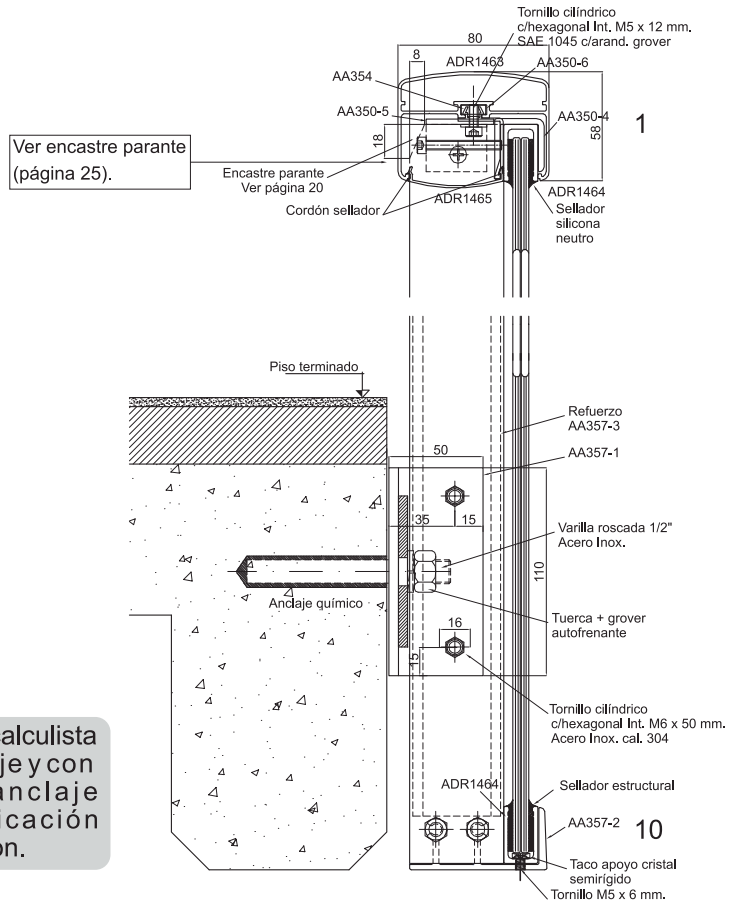
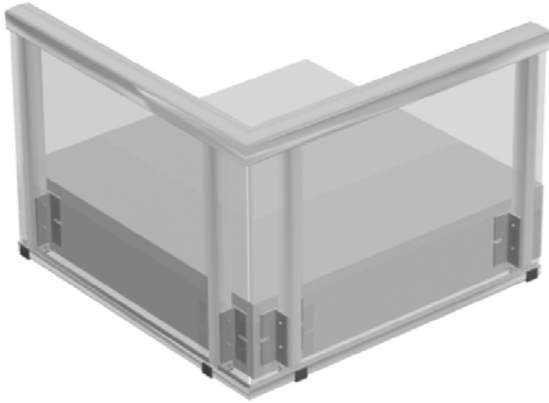

Verificar con calculista alto de anclaje y con fabricante anclaje químico aplicación sobre hormigón.

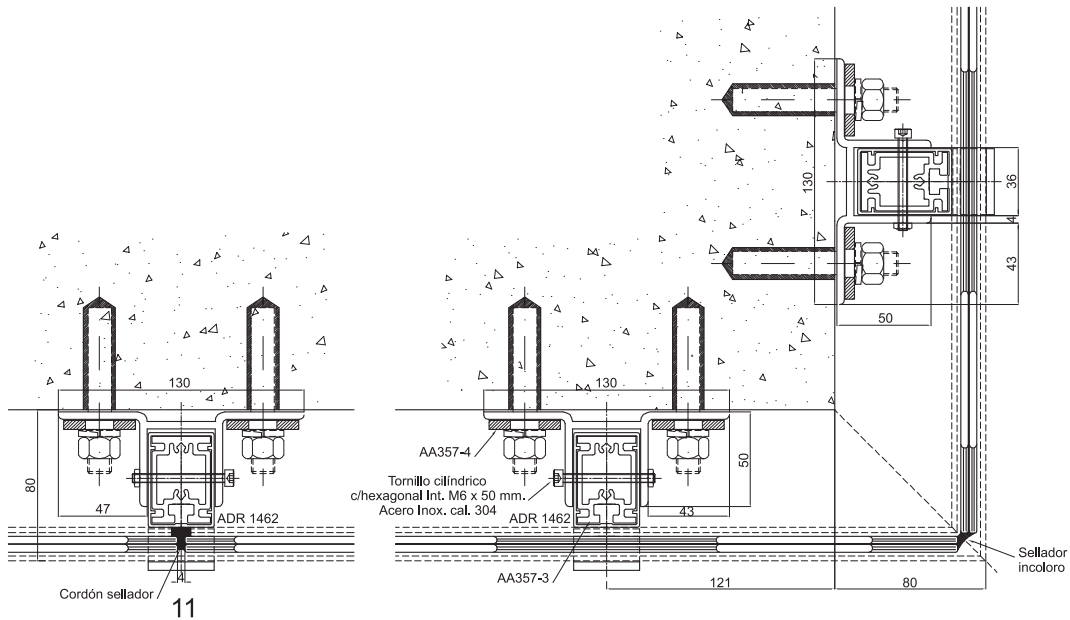

Accesorios complementarios

Detalle de ubicación Clip AA354

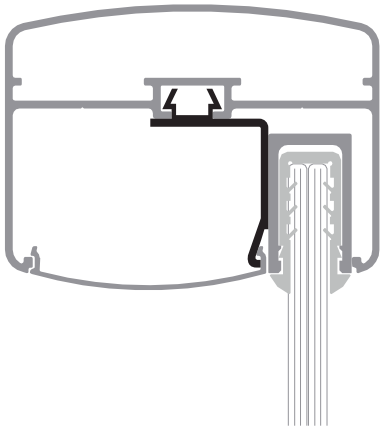

Clip Inferior Tapa Pasamanos
Código AA354



Burlete U para Cristal laminado 4 + 4 mm.
material EPDM
Código AG080E

Escuadra AA 352 / Acople AA 353

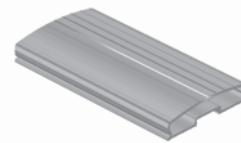
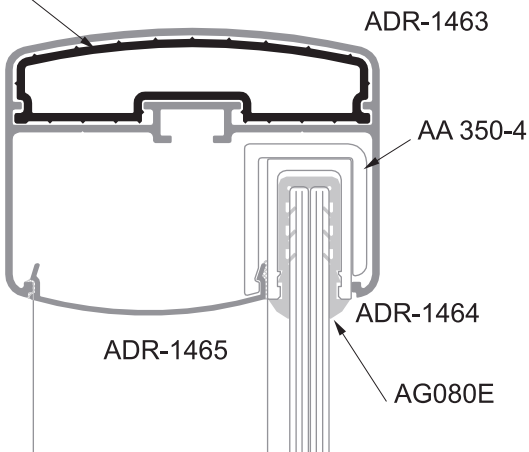

Alineamiento Pasamanos
Código AA353

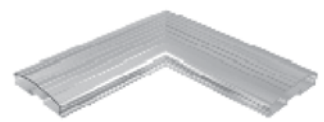

Escuadra Alineamiento
Código AA352

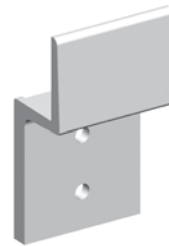

Soporte inferior U
Código AA351

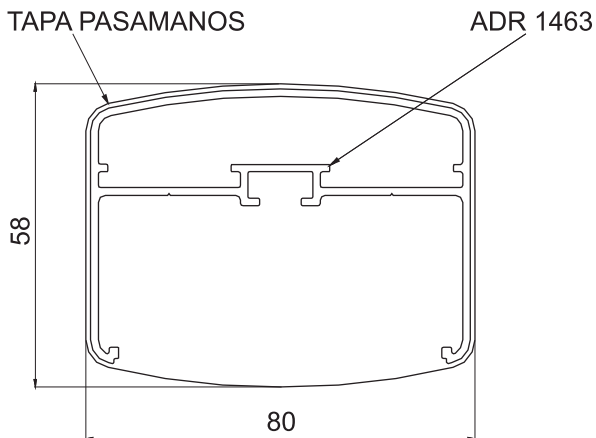

TAPA PASAMANOS AA 355

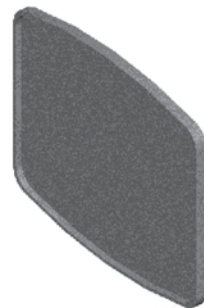

Accesorios complementarios

Acople AA358-8 / Escuadra AA358-9

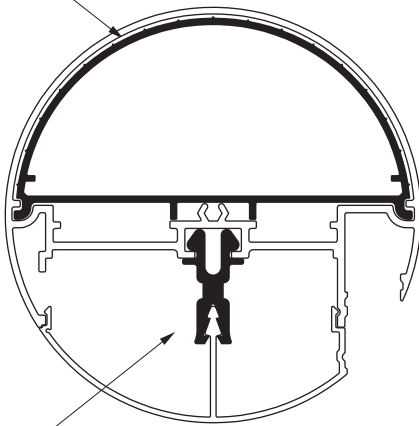

ADR-2771

Detalle ubicación
Clip AA358-6

ADR-2772

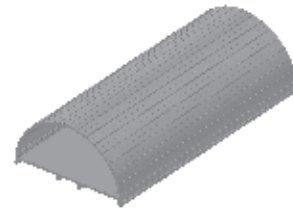

Acople
Código AA358-8

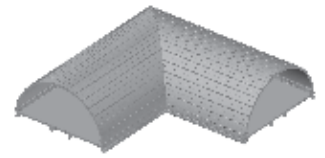

Escuadra Alineamiento
Código AA358-9

Acople AA358-10 / Escuadra AA358-11

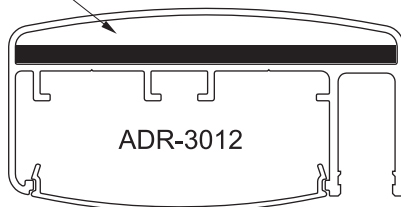

ADR-2706

ADR-3012



Acople
Código AA358-10



Escuadra Alineamiento
Código AA358-11

TAPA
PASAMANOS AA358-7
(para perfil 2771)



Detalle

Mecanizados ADR 1462

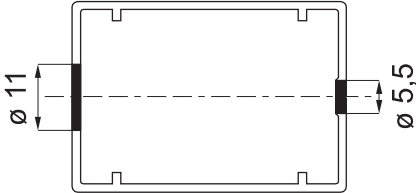
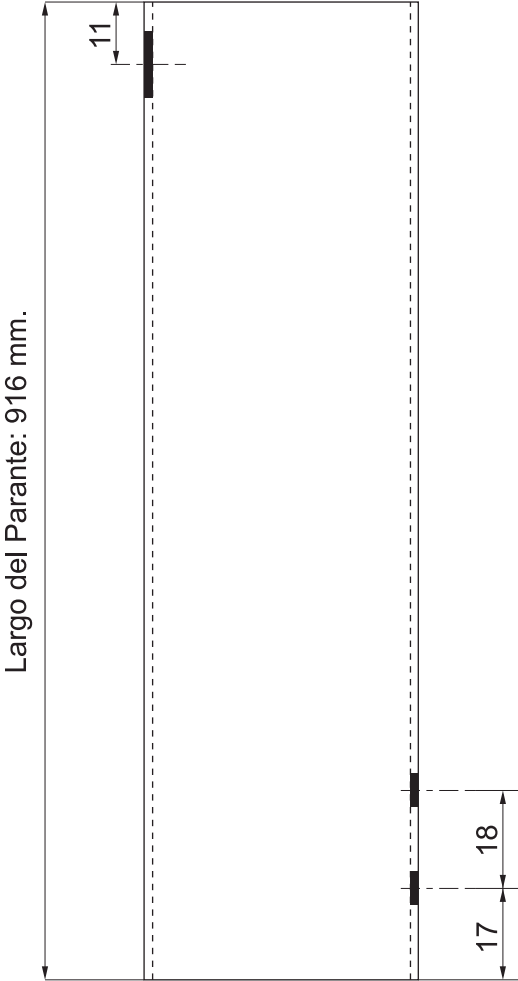

ADR 1462

Encastre parante perfil ADR 1462

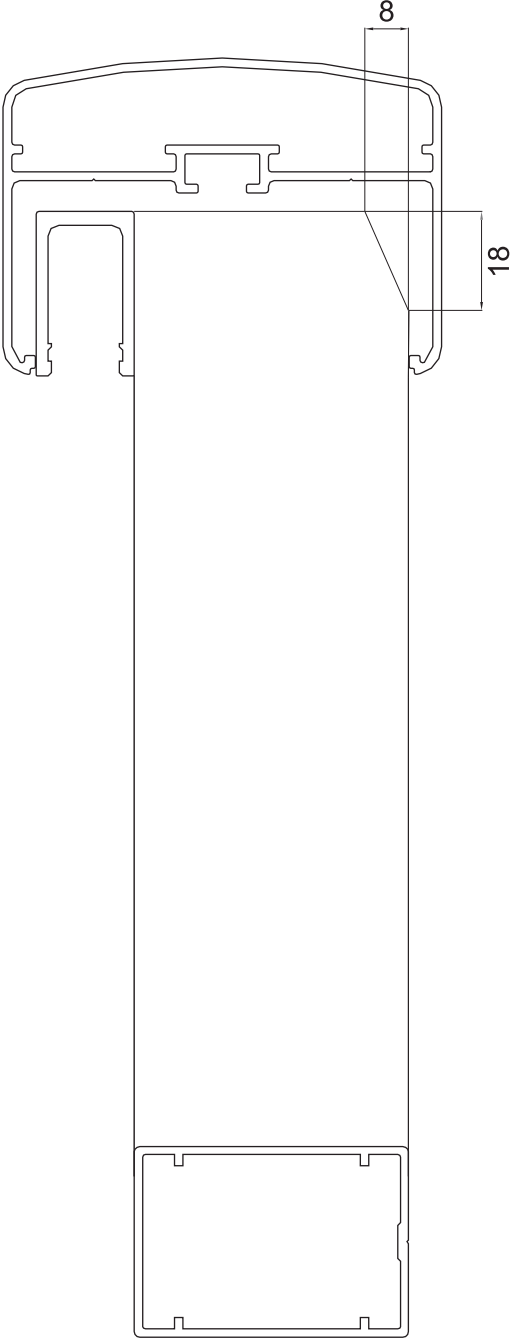

Colocación de anclaje y varilla roscada

Procedimiento para colocación de anclaje químico y varilla roscada

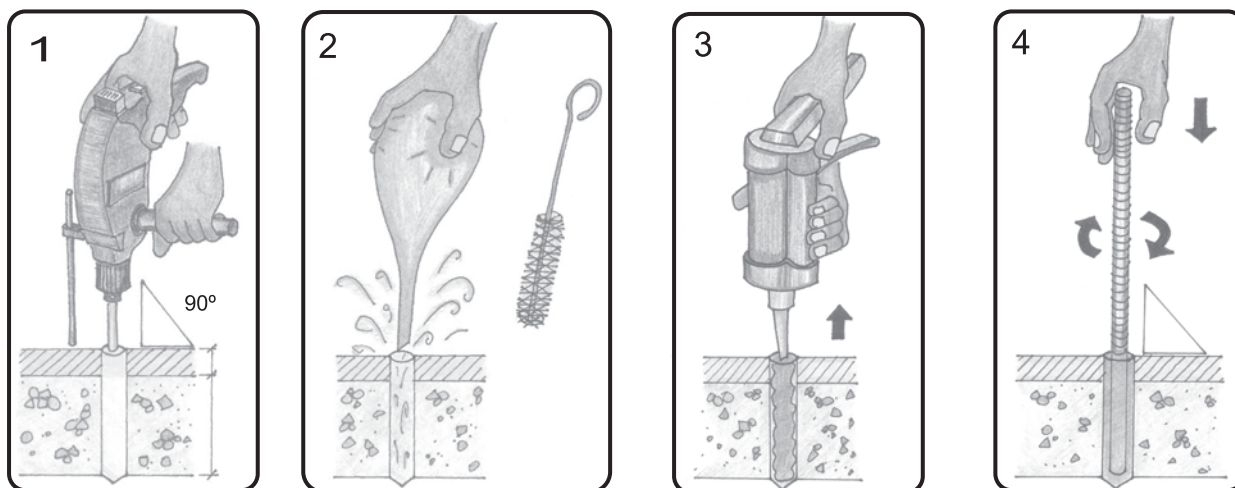

1. Taladrar un orificio de 14 mm. de diámetro y una profundidad de 100 mm., esta medida no incluye revestimientos sobre hormigón como contrapiso, cerámicos, etc. Se recomienda durante la operación mantener la perpendicularidad de perforación con respecto al piso.

2. Quitar los restos de polvo completamente, se puede utilizar agua presurizada o aire.

3. Comenzar la inyección del químico (*) desde el fondo del orificio hasta la mitad.

4. Insertar la varilla con un movimiento de torsión y comprobar que el químico haya llenado la totalidad del orificio. Controlar la perpendicularidad varilla / piso. Retirar los restos de químico cuidadosamente y respetar el tiempo de fraguado del producto seleccionado.

NOTA: El procedimiento detallado es genérico.

Es aconsejable consultar al fabricante y/o proveedor del químico, ante cualquier duda sobre rendimiento volumétrico, tiempo de fraguado, etc.

(*) Ver "Precauciones de Seguridad" página N° 28.